

\$2

# Washington Apple Pi



Volume 4

August 1982

Number 8

## Highlights

COOLING A HOT APPLE

JUMPING OUT OF A FOR NEXT LOOP

THE NEW ABBS PART II

SWITCH SELECTED ENABLE/DISABLE

## In This Issue

MEMBERSHIP INFORMATION, EVENT QUEUE		3
MINUTES - BOARD AND GENERAL MEETINGS		4
CLASSIFIED		5
PRESIDENT'S CORNER	DAVID MORGANSTEIN	6
A PAGE FROM THE STACK	JILL & VANCE GIBONEY	7
SIGAMES	DONN HOFFMANN	8
COOLING A HOT APPLE	TOM VAN FLANDERN	9
Q & A	BRUCE F. FIELD	10
APPLESEEDS	DAVID STERN	12
SOFTVIEWS: Recent Releases	DAVID MORGANSTEIN	14
ELECTION REPORT	ROBERT PLATT	18
HOTLINE VOLUNTEERS WANTED		18
JUMPING OUT OF A FOR NEXT LOOP	JAMES T. DEMAY, JR	20
THE NEW ABBS, PART II	TOM WARRICK	22
EDSIG	NANCY C. STRANGE	22
LETTER TO THE EDITOR	TOM VAN FLANDERN	24
CONSUMER'S UNION		24
SWITCH SELECTED ENABLE/DISABLE FOR SLOT ZERO	DAVE WEIKERT	26
IAC CORNER	BERNIE URBAN	30
TUNING OUT THE AUDIO	JANE MASON	30
LIBRARY ORDER FORM		31
WAP TUTORIAL REGISTRATIONS AND NOTICE		32



# ComputerLand<sup>®</sup>

Tysons Corner

 **apple computer**  
Authorized Dealer

8411 Old Courthouse Road  
(at Route 123)  
Vienna, Virginia 22180  
**Sales (703) 893-0424**  
**Service (703) 893-0114**

# Turrís Eborá Computer

## \*\*\* HARDWARE \*\*\*

### SUPER SPECIALS--

- Rana Systems 5 1/4" drives (40/80 track, single-/double-sided (163K--652K per drive). Use w/ Apple controller or with 4-drive Rana controller card... (Call for info)
- MicroSci 5 1/4" drive (100% Apple plug-compatible) .... 319 (Shugart 390--same as Apple) with controller ... 385
- Microsoft Premium System-- Microsoft Z-80 card w/ CP/M, MBASIC, GBASIC; Microsoft 16K RAM card; Videx 80-col card w/ inverse ROM & Softswitch; Osborne CP/M manual ALL of the above (lists for over \$1000) ..... 529
- Davong 5-MEG Winchester drive (complete system !!) ... 1595

### MONITORS--

- Zenith 12" green screen (15 Mhz--a great value) ..... 105
- NEC 12" green screen (20 Mhz, anti-glare screen) ..... 159
- Andek 12" 300G (18 Mhz, anti-glare screen) ..... 155
  - 13" Color I ..... 339
- Sanyo 9" green screen ..... 155
  - 12" green screen (18 Mhz--new model, anti-glare ) 195

### MODEMS--

- D.C. Hayes Micromodem II ..... 269
  - Smartmodem (RS-232, ASCII-programmable) .... 209
- Novation Apple-Cat II (212A option available) ..... 279
- Universal Data Systems 212 LP (1200 baud full duplex) . 375

### PRINTERS--

- Epson MX-80 with new GRAFTRAX-Plus ..... 459
  - MX-80/FT tractor/single sheet & GRAFTRAX-plus.... 499
- NEC 8023A (100 cps--pin, friction, graphics) ..... 469
- C. Itoh Prowriter (100 cps--pin, friction, graphics) .. 459
- Okidata 82A (120 cps--pin, friction feed) ..... 429
- Transtar 140 (40 cps daisy-wheel, same as Itoh F-10) . 1299

### INTERFACES--

- Pkaso printer interface w/ graphics ..... 135
- Grappler printer interface w/ graphics ..... 135
- Mountain Hardware CPS Multifunc. (Ser. + Par. + Clock). 165
- Wizard BPO 16K--32K buffered parallel (graphics option) 145
  - SOB 16K--32k buffered serial (RS-232) ..... 189

### VIDEO--

- Videx Videoterm 80-column display ..... 239
  - Enhancer II ..... 119

### MEMORY EXPANSION--

- Mespercorp Wizard 16K RAM card (2-year warranty) ..... 89
- STB Systems 64K RAM card (w/ disk emulation software) . 209
  - 128k RAM card (as above) ..... 349

## \*\*\* SOFTWARE \*\*\*

### VISICORP--

- Visicalc ..... 185
- Visifile ..... 185
- Visitrend/Visiplot ..... 220
- Visipak (all of the above) ..... 495
- Visiterm ..... 85

### WORD PROCESSING--

- ScreenWriter II (new & improved SuperScribe) ..... 95
- LJK Letter Perfect ..... 105
- Super-Text 40/80 column ..... 129
- WordStar ..... 195

### INFORMATION MANAGEMENT--

- dBASE II ..... 459
- DB Master ..... 159

### APPLESOFT COMPILERS--

- On-Line Expediter II ..... 75
- Microsoft TASC ..... 125
- Hayden compiler ..... 125
- SpeedStar ..... 99

### COMMUNICATIONS--

- Visiterm ..... 85
- Data Capture 4.0 40-column ..... 49
  - 80-column ..... 70
- Ascii Express ..... 59
- Z-term ..... 79
- Z-term Professional ..... 105

### CP/M SOFTWARE FOR APPLE--

- Microsoft Fortran-80 Compiler ..... 149
  - Basic-80 Compiler ..... 259
  - Cobol-80 Compiler ..... 475
  - A.L.D.S. .... 95
- MicroPro WordStar ..... 195
- MailMerge ..... 79
- SpellStar ..... 119
- CalcStar ..... 119
- SuperSort ..... 119
- DataStar ..... 169

-----  
 ! also available:  
 ! COMPUTERS: Altos, Atari, Xerox, Northstar, Archives, NEC, !  
 ! Godbout, Zenith, ADDS, California Computer Syst!  
 ! HARD DISK SYSTEMS: Corvus, Davong, Konan, Xcomp !  
 ! DAISY-WHEEL PRINTERS: Qume, Diablo, NEC, Itoh, Smith-Corona!  
 ! and: Televideo, Novation, Anadex, SVA, SSM, IDS .... !  
 -----

PLEASE.... COMPARE OUR PRICES with ANYONE else in town.... MOST are the LOWEST IN THE COUNTRY !!!

All items carry full manufacturer's warranties. Md. residents add 5% sales tax. UPS shipping is available, or you may pick up order locally or at Apple Pi meeting. Many other items are available -- let us know what you need and we'll get you a bargain.

TO ORDER: CALL (301) 454-6101 (days) or (301) 422-6458 (anytime) to place order (ASK FOR JEFF DILLON).

or

MAIL Certified Check or Money Order (personal checks are OK, but slow down your order).

to >>>> TURRIS EBORA COMPUTER, 7700 Adelphi Rd. #32, Hyattsville, Md. 20783

# There's only one place to buy apples.

AT FREDERICK COMPUTER PRODUCTS !!!

As an Authorized Apple Dealer we offer a full selection of both Apple Hardware and Software at low, low prices.

Also, as an Authorized Service Center we provide fast and efficient service on all Apple products.



## **FREDERICK COMPUTER PRODUCTS, INC.**

Microcomputer Systems And Peripherals

5726 INDUSTRY LANE-FREDERICK, MD.- (301)694-8884

 **apple computer**  
® Authorized Dealer

# OFFICERS & STAFF

President -David Morganstein(301) 972-4263  
 Vice President -Dana Schwartz (301) 725-6281  
 Treasurer -Edward Myerson (703) 751-7997  
 Secretary -Paula Benson (202) 546-0076  
 Members-at-Large-Bernie Benson (202) 546-0076  
                   -Bruce Field (301) 340-7038  
                   -Nancy Philipp (301) 924-2354  
                   -Bernie Urban (301) 229-3458  
                   -Jesse Wagstaff (301) 937-4215  
                   -Rich Wasserstrom  
 Editor -Bernie Urban (above)  
 Associate Editor-Betsy Harriman (202) 363-5963  
                   -Mark Crosby (202) 488-1980  
                   -Jane Mason (301) 365-3888  
                   -Richard Gibson (703) 323-9495  
                   -Genevie Urban (301) 229-3458  
 Newsletter Staff:  
 Store Distribtn.-Jim Graham (703) 494-1848  
 Advertising -Eli Argon (301) 229-4229  
 Columnists:  
   VisiCalc -Walt Francis (202) 966-5742  
 Head Librarian -Gordon Stubbs (703) 750-0224  
 Library Staff:  
   -Ben Acton, Andy Baum,  
   -Bill Bowie, Van Kozak,  
   -Sarah Lavilla, Jerry Waller  
 New Disks  
 Disk Documen. -Jill and Vance Giboney  
                   -Boris Levine (301) 229-5730  
                   -Tony Untied (301) 241-8678  
 Group Purchases -Rich Wasserstrom (703) 448-0984  
                   (7:00 - 9:30 PM, Mon - Fri)  
 Arrangements -Jim Carpenter (301) 371-5263  
 General Counsel -Jim Burger (Shaw, Pittman,  
                   Potts & Trowbridge)  
                   daytime - (202) 822-1093  
 Membership Program -Bob Peck  
                   -Ernie Forman (703) 241-1216  
                   -Tom Woteki (202) 547-0984  
 Rules&Elections -Bob Platt (202) 223-1588  
 SYSOP -Tom Warrick (202) 333-4000  
 Tutorials -Steve Stern (301) 881-2543  
                   -Joe Silverman (301) 384-1285  
 Volunteer Coord.-Boris Levine (301) 229-5730  
 SIG Chairmen:  
   Appleseeds -David Stern (301) 881-2543  
   APPLE /// -Charles Dow (301) 460-3911  
   ASMSIG -Robert Palus (301) 776-3075  
   Business -John New (301) 577-7959  
   CP/M -Dave Neumann (301) 776-6133  
   EDSIG -Peter Combes (301) 871-1455  
   FORTH SIG -Bill Wurzel (301) 593-2258  
   NEWSIG -Bernie Benson (202) 546-0076  
   Pascal (PIG) -Tom Woteki (202) 547-0984  
   SIGGAMES -Jim Eatherly (202) 232-6046  
   SIG/DISABLED -Curt Robbins ABBS WAP428  
                   8805 Barnsley Court  
                   Laurel, MD 20708

Washington Apple Pi  
 P. O. Box 34511  
 Bethesda, MD 20817  
 (301) 621-2719

ABBS (301) 657-4507

Copyright Washington Apple Pi 1982

Apple user groups may reprint without prior permission any portion of the contents herein, provided proper author, title and publication credits are given.

Membership dues for Washington Apple Pi are \$18.00 per year, beginning in the month joined. If you would like to join, please call the club phone and leave your name and address, or write to the P.O. Box above. A membership application will be mailed to you.



## EVENT QUEUE

Washington Apple Pi meets on the 4th Saturday of each month at the Uniformed Services University of the Health Sciences (USUHS), Building B, 4301 Jones Bridge Road, Bethesda, MD, on the campus of the National Naval Medical Center. Sales, library transactions, newsletter pickup, etc. are from 8:30 - 10:00 AM. From 9:00 to 10:00 AM there will be an informal "Help" session in the auditorium. The main meeting starts promptly at 10:00, at which time all sales and services close so that those volunteers can attend the meeting.

Following are the speakers and topics for the next few months:

August 28 - Bruce Field & Bill Wurzel  
                   FORTH  
 Sept. 25 - Jim Burger & Ken Hautman  
                   Copyright

Subscriptions to the Washington Apple Pi Newsletter are not available. The newsletter is distributed as a benefit of membership.

# EXECUTIVE BOARD MEETING

## MINUTES

Washington Apple Pi Board met on 9 June 1982 at 7:30 at the Urbans. President Morganstein presided; 21 people attended.

A motion passed that \$1200 for a hardcopy library be added to the budget being written. An amendment passed to include \$1000 for photocopy facilities for six months. Articles of Incorporation were presented and approved. Our 501 c 7 status with IRS has been approved. A motion to limit sales to non-members of the newsletter and back issues was tabled for one month while our c 3 status is clarified. Copyrighting club disks was discussed. The elections will close 21 June. The Board will not meet at the Urbans during July and August. The budget for next year was presented. Adjournment at 10 PM.

## GENERAL MONTHLY MEETING

Washington Apple Pi met on 26 June 1982 at USUHS at 10 AM. President Morganstein presided; about 282 people attended. Announcements were that we are now incorporated as Washington Apple Pi Ltd. and recognized by IRS as a not for profit organization. Volunteers are needed to help 4-H with computer training. An advanced Visicalc tutorial will begin on 10 July. A Logo SIG (special interest group) is being formed. The Board will meet in July at the Morgansteins.

New officers elected are board members - Rich Wasserstrom, Bernie Urban, Bruce Field, Nancy Philipp, Bernie Benson and Jess Wagstaff; Treasurer - Ed Myerson; Secretary - Paula Benson; Vice President - Dana Schwartz and President - David Morganstein. Straw votes on the ballots favored incorporation, a club office, general access to the office, and a fee for new members. The budget for next year was approved. It included office expenses with a hardcopy library and photocopy facilities, parttime help, accountant, newsletter setup, and disk copying. A motion passed that the Board make reasonable efforts to distribute copies of the budget to members. The presentation was made by Tom Riley on predicting the future. &

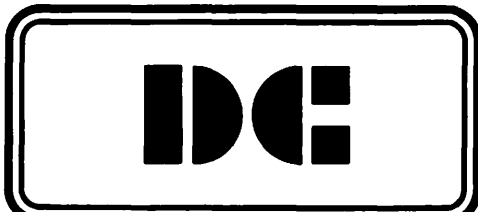
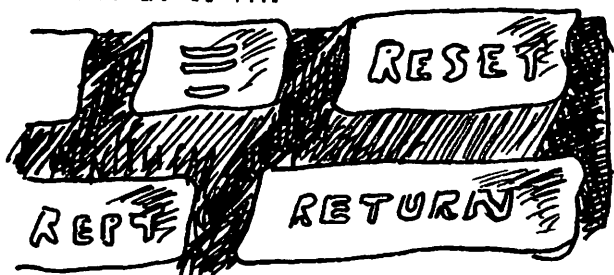

9174 Broken Oak Place  
Burke, VA 22015  
(703) 455-3432

### Disk Connection

#### WE HANDLE:

- CDC ..... \$31.00
- Wabash ..... \$27.00
- Verbatim Data Life. . \$27.00
- Plastic Library Boxes  
(with disk purchase) ... \$2.50
- Nibbles Away II or  
Master Key + ..... \$69.50

#### ALSO AVAILABLE:

- Flip-Files ..... \$22.00
- Plastic Pages (25) ..... \$12.50
- Disk Saver Kits ..... \$10.00

WE CAN  
DELIVER TO  
WAP OR NOVAPPLE  
MEETINGS  
OR  
INCLUDE \$2.50  
FOR UPS SHIPPING

VIRGINIA RESIDENTS ADD 4% TAX

# CLASSIFIED

## FOR SALE

SubLogic A2-3D1, \$35; Data Transforms Graphtrix, \$35; Microsoft Typing Tutor, \$12; Mindstorms by Papert (about Logo), hardback, \$6.00; 12" black and white monitor (needs alignment), \$35. Call Jay Thal (w) 755-7330 (h) 244-3649

Apple III computer, \$2650. BMC monitor, \$150. Kishore Mahbubani 686-7432

D C Hayes Micromodem II with Microcoupler II, \$250. Call Curt Robbins, 8 AM-2 PM, weekdays only 443-1066

SuperScribe II; original disks and manual; used only three months. \$60. Contact Jim Reese, evenings 533-0601

Attention High School Students: Bone up on SAT tests with 48 excellent programs on 3 original diskettes for Apple II Plus. \$75 (half of original cost), or make offer. "Mystery House" Hi-Res Adventure #1, by On-Line. Original diskette. \$18 or make offer. "Phantom Five", by Sirius. Original diskette. \$15 or make offer. Goetz Dertel 299-4117

Visicalc, 13 sector, \$35; Letter Perfect, \$50; Visidex, \$50. R. Gibson 323-9495



Master Key+. Allows you to backup, list and modify protected programs. Requires 64K. With original documentation. \$35 (original cost \$70). Call Dave Weikert (301) 926-4461 after 6 PM

## TRADE

Have Hayes Micromodem II (new, unused). Want Videx videoterm 80 column board. Jim Metzger, evenings (703) 548-1893

## HELP WANTED

How does one interface Jameco JE-600 hex-dec encoder to an Apple? Call Jay Thal 244-3649

# INTRODUCING THE THIRD GENERATION OF INVESTORS' SOFTWARE FOR THE APPLE.

## THE INVESTOR'S TOOLKIT™

More complete than any other. Easier to use than any other. And you pay only for the systems you need. You can later "upgrade" any program package for just the price difference.

### PROGRAM PACKAGES

(consisting of the programs as numbered below)

Chart Trader (contains #1, 4) ..... \$149.00  
 Market Analyst (contains #1, 4, 15, 16) ... 249.00  
 Financial Trader (contains #1, 5, 6, 9, 15, 16, 17, 18) ..... 499.00  
 Professional Trader (contains #1, 3, 5, 6, 8, 9, 12, 14, 16, 17, 18) ..... 699.00  
 Chart Trader and Market Analyst also available with Graphic Charting with Analysis II (#5) for \$50.00 additional. Packages listed above may be upgraded for price difference only.

### DATA MANIPULATION

1. Data File Management . \$ 99.95
2. V-Comm ..... 99.95

### TECHNICAL ANALYSIS TOOLS

3. Advanced Graphics One \$199.95
4. Graphic Charting with Analysis ..... 99.95
5. Graphic Charting with Analysis II ..... 149.95
6. Gann Square of Nine .. 49.95
7. Swing Wave Day Counter 49.95
8. Fibonacci Projection .. 59.95

### TRADING SYSTEMS WITH OPTIMIZATION

9. Moving Average Crossover ..... \$149.95
10. Engineers System ..... 199.95
11. Parabolic System ..... 99.95
12. Directional Movement System ..... 99.95
13. Swing Index System ... 99.95
14. Relative Strength Index System ..... 99.95

### TRADING SYSTEMS

15. Wilders 6 Systems .... \$129.95
16. Relative Strength Index Trading System ..... 49.95
17. Engineers System ..... 69.95
18. Colver Method ..... 39.95
19. Trend Master ..... 99.95
20. CSR 1: Moving Average with % Price Band ..... 79.95
21. CSR 2: Directional Indicator ..... 79.95
22. CSR 3: L-S-O Price Channel ..... 79.95
23. CSR 4: Range Quotient System ..... 79.95
24. CSR 5: M-II Price Channel ..... 79.95
25. CSR 6: Dual Moving Average ..... 79.95
26. CSR 7: The Outside Price Channel ..... 79.95
27. CSR 8: Reference Deviation System ..... 79.95
28. CSR 9: Trend-Countertrend Hybrid .. 79.95
29. CSR 10: High-Low Moving Average Breakout ..... 79.95

Send \$5 (credited to your first purchase) for a demonstration disk (if you don't have an Apple, any dealer will run it for you). Mastercard and Visa holders order toll-free, 1-800-835-2246. (Demo not available through 800 number.)



222 SO. RIVERSIDE PLAZA  
 CHICAGO, IL 60606  
 312-648-4844

Software by  
 Orion Management, Inc.

Apple is a registered trademark of Apple Computer, Inc.

# PRESIDENT'S CORNER

by David Morganstein

The arduous task of electing new officers and a new Executive Board is complete. There are several new faces and many familiar ones who have been given the task of managing the WAP's activities during the next year. I look forward to the challenges facing us as I am sure all of those elected do. (That look includes both pleasure and pain, both grins and grimaces...I can assure you...)

Elections seem to inspire thoughts of the past as well as the future. It has been a long and rewarding year. The past 12 months have seen us grow from 500 to 1500. Our meeting location moved to one with ample parking and rooms for SIG's; we have been able to provide extended opportunities during our gathering. The Pi now contains a schedule of upcoming meeting topics and speakers to alert members of subjects of interest. The pre-meeting question and answer session provides a chance to get help in solving nagging problems. The hotline has become a valuable resource on an ever-expanding list of subjects. Four tutorials were held and more are planned for the future. Our magazine has clearly become one of the best club publications in the country. Both the magazine and the software library have kept up with our tremendous growth in spite of the increasing demand on our diligent volunteers.

Of course, those volunteers, elected or otherwise, are the reason for our success. Without the many hours given freely and with enthusiasm from all of you who have stepped forward, we would not be an organization with a national reputation for helping our members to get the most from their Apple. Obviously excitement about our hobby and a willingness to share motivates many of you. However, I would like to add a heart-felt thank you from the many who benefit from the gift of your time. You are the ones who have made our club possible.

• • • • •

The results of the straw vote taken during the election seemed to support our growth and a move toward a more formal structure. We have already become a "corporation" thanks to the pro bono efforts of our General Counsel. We are seeking office space which will be open to the public and which will contain a reference library of books and magazines. (Please re-read Jeff Wagstaff's article last month to see how you can contribute to that collection.)

In addition to the office space and library materials, the budget passed at the June meeting contains funds for office equipment, a half-time staffer and the purchase of word-processing and magazine lay-out services. A one-time initiation fee of up to \$10.00 and a dues increase of up to \$6.00 was authorized. As the year continues, the board will evaluate the need for these additional funds and will enact the changes if and when it is clear that they are required. For those who could not attend the June meeting, a copy of the budget can be obtained by sending a self-addressed stamped envelope to the Post Office Box. Alternatively, copies will be available at future meetings for those interested.

• • • • •

For those who think that computers can "do anything", try writing a program to get your six month old to eat her creamed carrots without getting them all over the place. You may use any language you wish...(GIGO = goosh in, goosh out).

• • • • •

Authors of articles planned for next month's issue, please get your copy in to Betsy Harriman as soon as possible. She would like to have as much time as possible to "put it all together". We are looking for regular columnists for a variety of subjects. A columnist would both write articles, assist others who want to write articles and suggest topics to stimulate interest. Columnists for Pascal, CP/M, hardware, business application are just a few of the subjects we would like to cover. ☺

## STOCK MARKET AND STOCK OPTION PROGRAMS

### ★★★Stock Market Utility Programs★★★

Provides a complete data base management system for creating and modifying individual stock data files and a graphical evaluation of comparative stock performance.

Five programs provide for entry and storage of stock data, data correction, autoscaling Hi-Res graphical display of performance, and building historical data files electronically from downloaded MicroQuote data. \$80.

### ★★★Electronic Stock Package★★★

A complete system including a password for accessing, retrieving, storing, and updating individual stock data files electronically using the Dow Jones Stock Quote Reporter. \$120. (An extra option allows the use of the CCS clock card for automatic data access.)

### ★★★Stock Option Analysis Program★★★

Uses the Black-Scholes model to calculate the fair price of options and then calculates the expected profit or loss from any trade or spread involving up to three classes (e.g. horizontal spreads, vertical spreads, straddles, butterfly spread, etc.) of options on any one underlying stock for any time until the option expires. Supports user definable commission schedules, printer, hard copy graphics, and one or two disk drives. \$250. Manual (alone) \$25.

## H & H SCIENTIFIC

Specializing in Investment Software  
13507 Pendleton Street  
Fort Washington, MD 20744  
Tel. (301) 292-3100





# A PAGE FROM THE STACK

## by Jill and Vance Giboney

So, we ask ourselves, where are all the contributions? Isn't anyone typing in the listings from magazines any more? Or writing a short routine of their own to do something interesting? For the past couple of months we've been able to add a number of new disks to the library each month. At the same time, however, we've been receiving fewer and fewer contributions. While we do get programs and disks from other sources, the main source of programs for the WAP library is WAP members. In fact, the whole idea of the library is that it offers members an opportunity to obtain and exchange public domain software, and without the support of WAP members it is difficult to keep the library growing.

So, how do you contribute? To encourage contributions the library will exchange a disk from the library for each disk that you contribute. Your contributed disk does NOT have to be a full disk. It can contain a single program or a number of programs. The only restriction on contributions is that they cannot be copyrighted. If you've typed in a program from a magazine or written a program you'd like to share with other members simply make a copy of it and bring it along to a WAP meeting and exchange it at the library table. We need your contributions!

-----  
This month we're adding three new disks to the library.

Volume 120 is the new IAC disk #16, a miscellaneous collection of programs from The Green Apples of Cedar Falls, Iowa. Wondering what kind of software they're writing in Iowa? This is your chance to find out.

We're also pleased to be able to add the first disk from the Education SIG, and in the hope that there will be many more we're starting a new set of numbers with it. The first EDSIG Disk is EDSIG1 and contains programs on Elementary Math.

Are there any other SIGs that would like to start a series of disks?

Also beginning a new set of numbers is the first WAP tutorial disk, TUTORIAL1, Visicalc. Note that these disks are NOT in themselves tutorials. Rather, they're new disks that are intended to be used in conjunction with the Visicalc tutorial.

✶

\$\$\$ DISCOUNT PRICES \$\$\$

2% Discount  
for Certified Checks

D.C. Hayes Micromodem II .....	\$ 280
D.C. Hayes Smartmodem .....	\$ 230
Universal Data Systems 202 LP .....	\$ 200
Universal Data Systems 212 LP .....	\$ 380
NEC 8023 Printer .....	\$ 475
PRISM 80 (Graphics, Sheet Feed, Sprint Mode) ....	\$ 1,100
PRISM 80 (above plus Color) .....	\$ 1,400
PRISM 132 (Graphics, Sheet Feed, Sprint, Color) ...	\$ 1,550
Okidata Micro 82 A .....	\$ 440
Okidata Micro 83 A .....	\$ 680
NEC 7710 Spinwriter (RS 232) .....	\$ 2,350
Grappler (Cable included - Specify Printer) .....	\$ 140
Micro Buffer II (32 K) - Specify Printer) .....	\$ 240
AMDEK RGB Color Monitor .....	\$ 750
AMDEK DVMBBOARD .....	\$ 145
NEC Monitor 12" Green .....	\$ 165
AMDEK 13 Color Monitor .....	\$ 330
Axlon Ramdisk 320 K .....	\$ 1,050
Microtek 16K Memory Board .....	\$ 85
Softcard Premium System (Z 80, 16 K & Videx) .....	\$ 525
Mu-Math .....	\$ 200
D BASE-AP .....	\$ 450
Wordstar-AP .....	\$ 200
LJK Letter Perfect .....	\$ 105
Visicalc 3.3 .....	\$ 185
Visiterm .....	\$ 85
Visiplot .....	\$ 150
Visidex .....	\$ 185
Visitrend / Plot .....	\$ 215
Visifile .....	\$ 185
Desk top Plan II for Apple on Disk .....	\$ 185
Visipak (Includes Visicalc, Visifile & Visitrend/Plot) ...	\$ 490
Visischedule .....	\$ 215

Also available:

Altos, Anadex, Atari, Konan, Micropro,  
Mountain Computer, North Star, Sanyo, Televideo  
and Ventel Products

### Call for Quotes for Items not Listed

- VISA/MC, money order, certified checks
- Prices subject to change without notice
- All items subject to availability
- No extra charge for VISA/MC
- Shipping & Handling 2% (\$5 minimum)
- MD residents add 5% tax

### RAMADA COMPUTER PRODUCTS

A Division of H & H Scientific  
13507 Pendleton Street

Fort Washington, Maryland 20744  
Telephone: (301) 292-3100



# SIGAMES

by Donn Hoffman

Sigames is the Washington Apple Pi special interest group concerned with the most important application of micro-computers, that is, of course, games. We meet every month following the regular WAP meeting in building C, lecture room D. All are welcome. The agenda is flexible; the meeting usually starts with a discussion session where attendees trade tips and field queries. This is followed by the main presentation (if there is one) after which newly released games are reviewed.

-----

This is somewhat of a catch-up article, as Sigames Reports has been missing from the last couple of WAP issues.

At a special meeting of Sigames in mid May, Rodger Keating from the Australian arm of International Apple Core made a guest appearance. The author of several wargames published through SSI, Mr Keating presented Southern Command and a new game of his that is yet to be released.

The regular May meeting was blessed with the appearance of Mr Silas Warner, co-founder of Muse Software and author of Castle Wolfenstein, ABM, and Robot War. Mr

Warner spoke about the publishing business, how to submit your software to a publisher, what he looks for in a game, and (of the greatest importance) what kind of royalties an author can expect. After his talk, Mr Warner demonstrated some new games from Muse: Fire-bug, Rubic's cube, and Frazzle.

-----

At the June meeting, Jeff Stetekluh gave an informative lecture on computer graphics. He spoke on the need for speed, line-drawn graphics, 3D and hidden line graphics (demonstrated with SubLogic's Flight Simulator), and character-set animation (created with the aid of Pascal Animation Tools from Apple's Special Delivery Software). In addition, Jeff showed some of his own programs, among them a tank game, and a rotating star which utilized page-flipping from Pascal. Many thanks to Jeff.

-----

XTXIXPXS

For the benefit of those who have been unable to attain puissance in On-line's Cannonball Blitz, this section has been included. The following procedure will permit language-card (or any 16K RAM card) users to get a few extra men and begin on any level.

First, WITH THE POWER OFF, move your RAM card to slot 1. (Do this EXTREMELY CAREFULLY!!!) Now, power up (DOS need not be loaded), and enter the following commands:

```
lcall -151 (enter the monitor)
XD000<D000.FFFF (move monitor
                    into RAM card)
*FA85:A9 80 8D 12 6F 4C 1B 61
                    (also try changing the
                    last 2 bytes to: 28 A0)
*C090 (write-protect RAM card)
(insert Cannonball Blitz in drive)
*6 ctrl-P (boot up)
```

Begin the game and, when the music starts, press RESET. This should start the game over at level three (or level two if you used 20 A0); if it doesn't work the first time, try it again.

More Cannonball Blitz lore:

Do not jump over the flag, you cannot get back. On the second level, when you "die", keep the button depressed until the game resumes; there will be many fewer cannons.

If you know of any bugs, tricks, or short-cuts, please mention it at the Sigames meeting, or leave a message on the ABBS (to WP1261).

High Magnetic Quality

## DISKETTES

- \* From a major manufacturer.
- \* Usually sold in bulk without brand labels to dealers for insertion of their own labels.
- \* Buy unlabelled from us and save money. We deliver to meetings if paid in advance.

### \$ 2.00 EACH !

- \* Also available 2-sided at no extra cost. Both sides fully guaranteed.

VF ASSOCIATES  
6327 Western Ave., N.W.  
Washington, D.C. 20015  
363-1313 (a.m. & eves)

or

THE BOOK MARKET  
2603 Connecticut Ave.  
Open 7 days, 11-6  
FE-2-2310 (Call to  
verify stock on hand.)

# COOLING A HOT APPLE

by Tom Van Flandern

I'm back this month with another money-saving tip. If you have several boards plugged into your Apple and it is starting to run a little on the warm side, you may need a fan, as has been extensively discussed in past issues of this newsletter. However there is a much cheaper and simpler alternative which may postpone the day of reckoning, as well as prolong the lifetime of your present boards and power supply. Just move your present power supply from inside your Apple to outside of it. Even if you already have a fan installed, this step may further reduce the interior heat. The task is indeed a trivial one, and can be done safely by the greenest of novices. The only disadvantages I can think of are the additional surface area needed for the power supply to sit where it won't be knocked off, and the nuisance of a separate part to carry if your Apple is portable. Of course your power-on switch will also be relocated by this process, since it is built into the power supply.

I will now give a detailed description of the steps for novices, although, as you will see, they are almost obvious without discussion.

**STEP 1.** Unplug your Apple and disconnect the cord from the back of the Apple, which happens to be the back of the power supply also. Remove the cover. With power off, you might wish to remove your peripheral cards from their slots in the back of the Apple also, just to make access to the underside of your machine easier.

**STEP 2.** Tip the Apple up onto its right side, which will swing the power supply side up. Examine the underside of your Apple. Locate a rectangular pattern of four Phillips-head screws holding the power supply in place. (The power supply is the metallic rectangular box at the left rear of your Apple, about 10 inches long, usually copper-colored.) None of the four screws is along the edge of the bottom plate. The three closest to the edge are about an inch inside it.

**STEP 3.** Holding the power supply so it won't fall when you free it, remove the four screws. Return the Apple to its normal sitting position.

**STEP 4.** Now only the cable of colored wires connecting the power supply to the Apple prevents you from removing it. Grasp the connector at the end of this cable in front and back with two fingers. Squeeze and pull up. It should pop out easily. (Note: If the connector does not come loose easily, note that it is held in place by a tiny latch on the connector, which must be squeezed to free it. Then some very gentle rocking motion should overcome whatever friction still holds it in place.)

**STEP 5.** Place your power supply outside your Apple, and thread the colored cable back into the Apple through the large hole in the rear, formerly blocked by the power supply. Reconnect the cable to the Apple. (It only goes in one way.) Push down until you will no longer pull up without squeezing.

**STEP 6.** You are done! Save the screws in a safe location, or attach them to the power supply with a piece of scotch tape, so you have them if you ever want to reverse the process. Plug the Apple's cord back into the power supply, and turn it on.

One final note--the power supply may generate a weak magnetic field, as well as heat, so it wouldn't be advisable to set diskettes on it.

Your Apple should now run much cooler, at a price you can afford!

Ⓒ



**It's never too late  
to start saving money**

**The ACCOUNTANT**  
Finance Data Base System \$129  
Optional VisiCalc™ Interface \$20

Allows you to define up to 63 codes.  
You'll save money when you prepare  
your taxes by having an accurate record  
of every legitimate tax deduction.

**Decision Support Software**  
1438 Ironwood Drive, McLean, VA 22101  
Call (800) 368-2022 or (703) 241-8316

Use your Visa or Mastercard. Include \$3.00 shipping and handling. VA residents add 4%  
APPLE™ is a trademark of APPLE Computer Inc. VisiCalc™ is a trademark of Personal Software Inc.

# Q & A

## by Bruce F. Field

This column is a funny business. Unless I beat on you people to send in questions we don't get very many! I recognize that advertising is required to sell a product, but to give away free advice? So, now that I've done my advertising duty for this month I'll just sit back to await the flood of letters.

Q. The WAP library disk #37 has a fine revision of File Cabinet named Super File Cabinet. When you do a manual search of files (or sort for that matter), all numeric records must have the same number of places (e.g. sorting or searching records or files numbered "1" to "1000" doesn't work). Hence, one has to input all data with the same number places by adding leading zeroes. So far so good. Unfortunately, one cannot search or change groups by record numbers because records were not set up with leading zeroes. Is there any way to amend this problem in Super File Cabinet? Any help would be appreciated.

A. The problem of searching by record number occurs because the search routine performs record selection using string comparisons. In Applesoft, strings are compared on a character-by-character basis where the "value" of the character is the ASCII value. Thus 10 is smaller than 8 because the value of the ASCII "1" is 49 whereas "8" is 56. There are two ways to fix this. One, you could make searching record numbers a special case where numbers are used instead of strings. This requires a fair amount of revision to the program. As you point out, adding leading zeros so that all the numbers contain the same number of digits also solves the problem, and this is much easier to do. First we need to define a string containing only zeros that will be used later to add leading zeros to the record number.

```
1065 RC$ = "0000"
```

Then the program line that converts the record number to a string in preparation for searching should be revised to include leading zeros.

```
1940 N$(J,0)=RIGHT$(RC$+STR$(J),4)
```

This statement will make all the record numbers 4 digits long when doing a search. To help you remember that leading zeros are used, it is desirable to also revise the record printing routine to print the record number with leading zeros.

```
2260 PRINT " H$(0) ": ";RIGHT$(RC$+STR$(J),4)
```

Leading zeros on the record number are required only when it is used as a search criteria, otherwise just the number itself may be used.

Q. I am writing a program and want to generate an array containing the numbers 1 to 100 in random order for a hangman program I am writing. I got this program from a friend - will it work?

```
100 DIM R(100)
110 FOR I=1 TO 100
120 A=INT(100*RND(1))+1
130 FOR J=1 TO I-1
140 IF A=R(J) THEN 120
150 NEXT J
160 R(I)=A
170 NEXT I
```

A. It will probably work, but may have some problems. The program generates a random number and compares it to all the previously generated numbers stored in array R. If it is not unique the program keeps generating more numbers until it finds one that is unique. The problem is that as the array fills up the chance of generating a number that has not been previously chosen decreases and it will take a lot of time to compare all the candidate numbers to the previously chosen ones. If the random number generator is a bad one, it is possible that some numbers may never be generated and the program will be hung up in an infinite loop.

A faster algorithm that requires generating only 100 numbers works as follows. Assume you have a stack of cards with the numbers 1 to 100 on them. Remove one card at random from the stack and set it aside. Now choose another card at random from the remaining 99 cards set, it on top of the first, and continue until all 100 cards are transferred from the first stack to the second stack. Since once a card is chosen it is removed from the stack, each successive pick has to be unique. An Applesoft program to do this is:

```
100 DIM R(100)
110 FOR I=1 TO 100:R(I)=I:NEXT I
120 FOR I=100 TO 1 STEP -1
130 X=INT(I*RND(1))+1
140 T=R(X):R(X)=R(I):R(I)=T
150 NEXT I
```

A bit of tricky programming was used so that only one array of numbers is needed. Obviously this is also a simple way to shuffle a deck of cards.

Q. When I list a Basic program how do I get my printer to print more than 40 characters on a line?

A. This is a very common question that is difficult to answer without knowing exactly what interface card and printer is being used. But, maybe if I can explain a little about how the Apple works

you'll at least know where to go to find the answer.

When you type PR#1 (or whatever slot number) the Apple directs all output to the interface card in the slot specified. What this means is that whenever the Apple is ready to output a character it does the machine language equivalent of a GOSUB to a memory address assigned to the interface card. The interface card must have a memory chip containing a machine language program that knows how to operate the printer. The key is the program in the interface memory as this program generally controls the number of characters printed on a line. Unfortunately there are as many ways to change the line width as there are interface cards, you will have to look in the manual that came with your card to see how to do it.

For the Apple serial card the line width is set by some switches on the card or by POKEing values in certain memory locations. The Apple parallel card is changed by "printing" CTRL-I80N where 80 is the width.

In general, but not always, if the interface is set to print to the screen as well as to the printer, you will only get 40 character on a line when listing a Basic program. When listing a program the Basic interpreter checks to see how close the printing is to the right hand screen margin. Once you get within about seven (I think it's seven) spaces from the edge of the screen, the interpreter starts looking for a space character in what it's printing. When it finds a space character it generates a carriage return, tabs over 5 spaces to get by the line number, and starts printing on the new line. This is done to prevent breaking a word or number in two at the end of the line. The look-ahead feature of the interpreter is disabled whenever you set the width of the screen to 33 or less. Then the interpreter prints out the whole Basic line without printing any carriage returns at the edge of the screen. The screen printing routine then takes care of doing a carriage return and line feed at the edge of the screen window, but this does not get sent to the printer.

Since I've rambled on here, let me summarize. If the printing goes only to the printer and not to the screen, the interface card to the printer has to be set for the desired printer width. If the printing also goes to the screen in addition to setting the interface card, you should do a POKE 33,33 to allow program listings more than 40 characters wide.



\*\*\*\*\*  
\*\*\*\*\*

We can meet most of your software and hardware needs. Call for price quotes and availability of business, word processing, and educational software and games. We also sell expansion boards, fans, monitors, printers, etc.

NEW!!! THE APPLE CARD --- a plastic reference guide to peeks, pokes, DOS & graphics commands, etc. ... \$3.25 or FREE with purchase of \$100.00 or more

DESCRIPTION	\$SALE\$
Master Type .....	30.95
Three Mile Island .....	30.95
Global War .....	18.75
Robot War .....	28.00
Robot Tank (3D).....	25.95
Wizardry II .....	27.50
T.G. Selectaport .....	45.00
T.G. Joystick .....	45.00
T.G. Paddles .....	30.00
Adam & Eve Game Paddles .....	30.00
Paddle-Adapple .....	26.00
GRAFTRAX 80 Graphics .....	70.00
Firebug .....	19.25
Frazzle .....	19.25
Nibbles Away II .....	48.00
VC/80 TM .....	40.00
&AmperMagic .....	56.25
Micro-Sparc, Inc. products	
Apple V.I.P. II .....	23.95
AmperSoft .....	39.95
Directory Master .....	23.95
Key Perfect .....	23.95
LexiCom .....	31.95
A.M.P. 2.0 .....	23.95
5" Flip N' File .....	25.00
Epson MX-80 Ribbons .....	14.25
As always, Verbatim diskettes	
Soft box .....	25.00/10 pack
Plastic case .....	27.00/10 pack
Verbatim 8" disks ..Call for prices	
Library cases .....	2.00

**D & H ASSOCIATES**  
11716 KEMP MILL ROAD  
SILVER SPRING, MARYLAND 20902  
301-649-6868

Sunday-Thursday, 9 A.M. - 9 P.M.

Free delivery to Crystal City  
Quantity Discounts Available

\*\*\*\*\*  
\*\*\*\*\*

# APPLESEEDS

## APPLESEEDS OFFICERS

President - David Stern  
 Vice President - Brian Van Flandern  
 Librarian - Mike Forman

## APPLESEEDS

Appleseeds is a group of kids who meet during the monthly WAP meeting. Our meetings consist of a speaker (first 30 minutes), presentations, and discussion of general points of interest. If you have special knowledge in a topic relating to the APPLE and would like to give a presentation for Appleseeds, please contact David Stern at 881-2543.

## COMPUTERS GO TO HOLLYWOOD

A new movie will be appearing in the theaters soon, and it will be different from any other movie you have ever seen. TRON, the new movie from Walt Disney, is all about computers and computer software. The story centers around the huge ENCOM corporation and its extensive chain of computers. The leader of these computers is actually a program itself, the Master Control Program (MCP). Alan Bradley, being denied access by MCP to his own program, seeks out computer whiz Flynn. Flynn breaks into the MCP, but no sooner does he find what he was looking for when a laser behind him zaps him into the computer itself. Inside, every computer game is a life or death duel and Flynn must fight for his life. Who will win, man or computer?

Another movie using computers is Evilspeak. About a computer whiz living in a military school, Evilspeak uses an APPLE computer as a star in the movie itself. The computer whiz, Stanley, discovers an underground chamber which was the final resting place of the devil-worshipping monk, Esteban. Stanley proceeds to program the Black Mass on the Academy's APPLE. The APPLE used in Evilspeak has some pretty fancy 'ultra' Hi-res routines and puts on a good show.

## REVIEWS

PROGRAM NAME ] NEPTUNE [ ]  
 PROGRAM AUTHOR ] NASIR GEBELLI [ ]  
 PUBLISHER ] GEBELLI SOFTWARE [ ]  
 PRICE ] \$29.95 [ ]  
 RATING (1 - 10) ] 7 [ ]

Neptune is another version of the arcade game "Scramble". In this game, you control a submarine which can either fire or drop bombs. Your enemies are the dreaded sea robots which infest the waters. You must destroy them and restore the waters to their rightful owners. Again, Nasir outdoes everyone else. A great game and well worth its price.

PROGRAM NAME ] CANNONBALL BLITZ [ ]  
 PROGRAM AUTHOR ] OLAF LUBECK [ ]  
 PUBLISHER ] ON-LINE SYSTEMS [ ]  
 PRICE ] \$29.95 [ ]  
 RATING (1 - 10) ] 8 [ ]

Cannonball Blitz is much like the arcade game "Donkey Kong". Cannonball Fortress, high atop Cannonball Hill, must be destroyed. In this game, there are three screens. The first consists of a series of ramps and see-saws. The second has little "pegs" you must pull out. The third (and the most challenging!) has an elevator, many sections of ramps, and a large cannon constantly firing huge cannonballs at you. Olaf Lubeck is now working on a version of "Frogger" for the APPLE.

## HIGH SCORES

Starting with this month's newsletter, Appleseeds will be maintaining a list of high scores set by Appleseed members. This month, only 7 scores have been reported. If you have a score which is higher than the one listed, or you have a game that you are good at and would like to have it listed, contact David Stern at 881-2543.

## HIGH SCORE LIST

GAME	SCORE	APPLESEED
ALIEN RAIN	592,080	STEVE GREEN *
ICBM	107,352	S.C.D. **
BUG ATTACK	19,530	DAVID STERN
CANNONBALL BLITZ	22,720	JEFF CAPLAN
ABM	26,000	S.C.D. **
SNEAKERS	18,789	JACQUI STERN
MOUSKATTACK	6,310	JEFF CAPLAN

\* Steve Green's score of 592,080 with a total of 581 flags was not achieved easily. Seven hours of work went into such a score, and I think that it should be recognized. (Although by the 5 hour mark, Steve had enough extra ships built up so that he could sit back for ten minutes, watching his ships get zapped away without any danger of losing.)

\*\* I received a letter in the mail a few days ago from some one named "S.C.D." In it were the high scores listed above. S.C.D.'s true identity remains a secret, but it has been said that he is indeed an Appleseed member. @

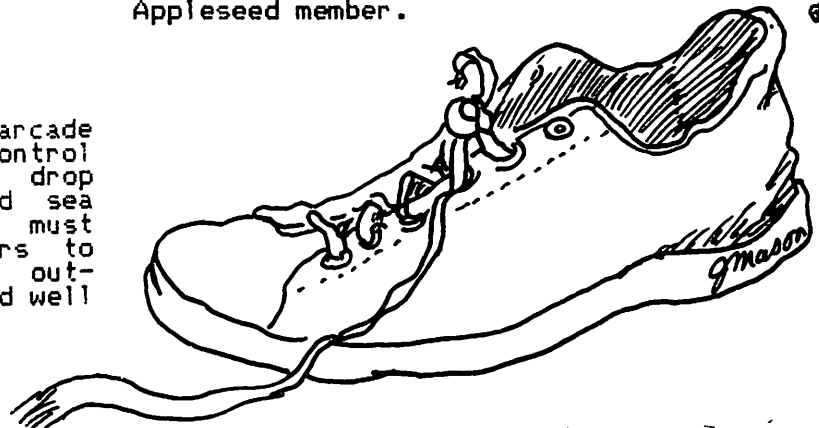

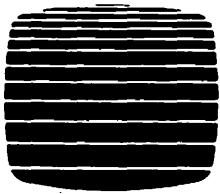

# THE COMPUTER WORKSHOP<sup>SM</sup>

A Collection  
of Specialty  
Computer  
Stores

1776 Plaza  
1776 East Jefferson Street  
Rockville, Maryland 20852  
**(301) 468-0455**

## PERSONAL COMPUTER CENTER

178 Rollins Avenue  
Rockville, Maryland 20852  
(301) 984-9292

*A Limited-Service Computer Store  
Handling the Sales and Rentals  
(Long & Short Term) of Personal  
Computers at Reduced Prices.*

*Featuring Atari, Apple, North Star,  
Panasonic and Commodore VIC-20.*

- Rent OSBORNE I's and APPLE II's  
by the hour, day, week or month.

**HOURS: Tues. - Sat. 12 Noon to 8 PM**

## RETAIL CENTER

1776 Plaza — Store #110  
Rockville, Maryland 20852  
(301) 468-0455

*A Full-Service Computer Store  
Prepared to Help You Select Your  
Small Computer System and Software.*

*Featuring Apple II, Apple III, Panasonic  
and Osborne I.*

- Word Processing
- Financial Planning
- Accounting
- Communications
- Portable Applications
- Music Synthesis

**HOURS: Mon. - Sat. 9 AM to 9 PM**

## EDUCATION CENTER

1776 Plaza — Store #108  
Rockville, Maryland 20852  
(301) 468-2399

*Education in the Use and Handling  
of Small Computer Systems  
and Software.*

- Osborne I Introduction
- CP/M
- Wordstar
- SuperCalc
- VisiCalc
- DBase II
- General Computer Operation
- Communications
- Basic
- Assembly Language
- Pascal

**HOURS: As Scheduled**

## SERVICE CENTER

1776 Plaza — Store #107B  
Rockville, Maryland 20852  
(301) 468-0901

*A Service Store Prepared to Repair  
Your Small Computers  
and Peripherals.*

*Specializing in the service and repair of  
Apple, Osborne, and North Star products.  
Other brands by special arrangement.*

- 24-Hour Answering Service
- Full Line of Parts in Stock

**HOURS: Mon. - Fri. 9 AM to 12 Noon  
Mon. - Fri. 1 PM to 6 PM**

**Bring in This Ad  
and Receive FREE  
a 5¼-inch Diskette  
Carrying Case!**

**The Computer Workshop — The Progressive Computer Store**

# SOFTVIEWS: Recent Releases

by David Morganstein

**BAG OF TRICKS.** For many who have read the exceptional "Beneath Apple DOS", the names Don Worth and Pieter Lechner will be as familiar as (dare I say) Apple pie. Their latest Bag is a collection of four utility programs and an accompanying 100-plus page manual describing their use. The four programs are:

1. **TRAX** - A program to read a disk and identify the codes used in the address and data header fields of the pre-nibblized bits on the track. It also displays the order of the sectors as they appear on the disk; this is relevant to the next program.

2. **INIT** - A program to reformat a single track, a range of tracks or the entire disk. It can preserve any data that exists during the reformatting process. It allows you to specify the order of the sectors as they appear on the disk. Since the sector order affects the speed at which a file is saved or read, redefining the sector numbers can greatly speed up disk access. (The sector arrangement is referred to as the skew factor).

3. **ZAP** - Perhaps the most powerful of the four utilities, ZAP allows you to read a sector of your choice, edit bytes and re-write the sector. While there are many utilities that do this, none are as powerful. ZAP has fifty commands and allows programmability with macros, labels and loops. The program even includes a calculator, an invaluable tool when adding and subtracting hex addresses.

4. **FIXCAT** - Clobbered a disk? This amazing program attempts the pseudo-religious task of raising the dead. It searches through the disk finding likely track/sector lists and then builds a catalog and VTOC using program names supplied by you. While there is no guarantee that it will work, it is the only version of such a utility that I have seen.

To learn to use the utilities, Don & Pieter included about a dozen sample applications. Among these are: improving access time, changing volume numbers, finding the A & L values of a binary file, patching DOS, releasing unused space in files, copying Pascal files to DOS, recovering lost sectors in the VTOC, and un-deleting a file. (Price \$39.95 from Quality Software, 6660 Reseda Blvd. Suite 105, Reseda CA. 91335, (213) 344-6599)

## MICROCOMPUTER SUPPLIES

### MINI FLOPPIES

Single side/ single density  
SYNCOM "Ectype" 22.00  
3M SCOTCH 25.99

single side/double density  
VERBATIM "DataLife" 28.50  
KYBE "Accutrack" 28.50  
3M SCOTCH 31.50  
SYNCOM "Ectype" 28.50

### CARTRIDGE RIBBONS

New film for Ricoh Printer each 4.75  
Recycled Ricoh film ribbons each 2.95  
DIABLO Hytype II black cloth doz. 44.75  
DIABLO High capacity film doz. 46.50  
EPSON MK 70/80 each 9.50  
IDS "Paper Tiger" each 10.75  
NEC Spinwriter film or cloth doz. 66.00  
NEC compatible film ribbons doz. 48.00  
QUME Black film or cloth doz. 33.95

### CONTINUOUS FORM PAPER

size	stk no.	wt.	sheets	price
9 1/2 x 11	6910PP	15#	3500	27.25
9 1/2 x 11	6910PP(20)	20#	2700	25.95
9 1/2 x 11	6910HSP	18#	3000	26.40
14 7/8 x 11	641	15#	3000	32.19
14 7/8 x 11	6410(20)	20#	2400	31.75

### MODEM

Lexicon LX-11 300 baud acoustic 145.00  
Signalman 300 baud 99.00

**ROBINS (Roberts Information Services, Inc.) (703) 560-5900 (800) 336-0198**

8306 Hilltop Road Fairfax, VA 22031  
(across from the Post Office in Merrifield)  
Monday-Friday 9 to 5 Saturday 10 to 2  
We ship by Capital Messengers and UPS



**SCREEN WRITER II.** Users of Superscribe II take note, a revised version of this excellent word processor has been released by On-Line Systems. Owners of Superscribe can get an up-date by contacting On-Line Systems...For those who are looking for a complete, low-cost word processor with more than a 40 column display, read on. Using NO external (expensive) hardware, Screen Writer provides an upto 70 column display on your monitor. This is done using an hi-res character set and the hi-res memory display. Not only does Screen Writer do all the usual and expected things using standard DOS data file for storage, but it provides: generation of an index, form letter capability and printer spooling. It will work with printers that can proportional space and will permit hyphenation of text to improve the appearance. It also supports footnotes! How about producing key click sounds from the Apple speaker? Yes, it gives typewriter realism with that little trick. Suppose you use the expression Washington Apple Pi a lot. You can define a single key (a keyboard macro) to mean the long string thereby saving a lot of extra typing time. What doesn't it do? (Get a six month old to eat her mashed carrots...) Personally, there is little else I would expect in a word processor.

The major differences between the new and older versions are: co-residence of the EDITOR and RUNOFF programs for owners of 16K memory cards and an improved, more readable manual. (Price \$125.00 from On-Line Systems, 36575 Mudge Ranch Rd, Coarsefold, CA. 93614, (209) 383-6858).



 **apple** + **SCM TP-1™** =

**PROFESSIONAL  
LETTER-QUALITY  
PRINT OUTS**

Combine your apple computer  
with the new Smith-Corona® TP-1  
letter quality electronic text printer  
for start-to-finish quality.

- daisy wheel allows font changes
- microprocessor electronics
- serial or parallel interface
- simple, reliable mechanism
- print speed: 12 CPS
- character set: 128 ASCII, 88 printable
- character spacing (pitch) 10 CPI or 12 CPI

SPECIAL APPLE SOFTWARE SALE - 20% OFF

**Price Breakthrough**  
**\$895 = letter quality printing**

**SEEING IS BELIEVING**

**HILA** INC

APPLE NATIONAL ACCOUNT DEALER  
5700-J Sunnyside Avenue  
Beltsville, MD 20705  
345-1123

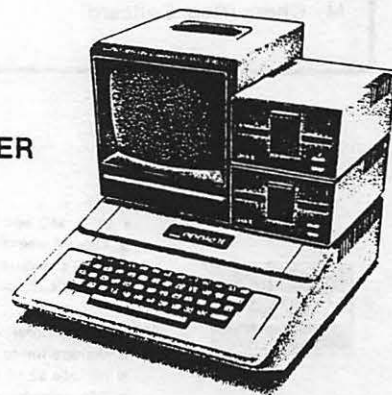
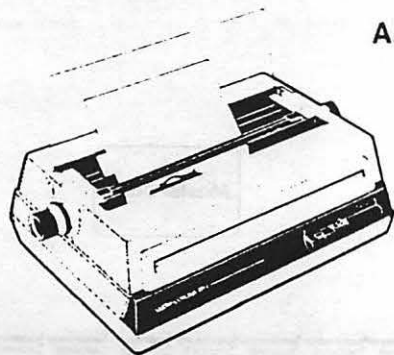

 **apple computer**  
Authorized Dealer

**CELEBRATE  
OUR  
Anniversary**

**CHOOSE A BONUS GIFT:**

With a minimum \$250 order,  
receive free **MOUSKATTACK**; or

With a minimum \$500 order,  
receive free **WIZARDRY II**; or

With a minimum \$750 order,  
receive free **TIME ZONE**; or

With a minimum \$1500 order,  
receive free **VisiCalc 3.3**



Bonus gift offer valid for all qualifying orders received or postmarked by August 27, 1982. No Substitutions.

**GAMES**

Battlesight	39.95	<b>29.95</b>	Neptune	29.95	<b>21.95</b>
Borg	29.95	<b>21.95</b>	Phaser Fire*	29.95	<b>21.95</b>
Castles of Darkness	34.95	<b>24.95</b>	Quadrant 6112	34.95	<b>24.95</b>
Choplifter	34.95	<b>24.95</b>	U-Boat Commander	34.95	<b>24.95</b>
Cross Country Rallye	29.95	<b>21.95</b>	Serpentine*	34.95	<b>24.95</b>
Crossword Magic 2.0	49.95	<b>35.95</b>	Snack Attack	29.95	<b>21.95</b>
Cytron Masters*	39.95	<b>29.95</b>	Snake Byte	29.95	<b>21.95</b>
Deadline	49.95	<b>35.95</b>	SwordThrust 6 or 7 (ea.)	29.95	<b>21.95</b>
Deadly Secrets	34.95	<b>24.95</b>	Threshold	39.95	<b>29.95</b>
Frogger*	34.95	<b>24.95</b>	Time Zone	99.95	<b>74.95</b>
M.I.R.V.	29.95	<b>21.95</b>	Ultima II*	59.95	<b>44.95</b>
My Chess (Req. Softcard)	34.95	<b>24.95</b>	World Builders	32.95	<b>23.95</b>

\*PreRelease Special



- VISA, MC add 3% (include card no. and expiration date).
- Allow 3 weeks for personal check to clear.
- COD's require 10% deposit—all COD charges to be paid by customer.
- Prices subject to change without notice—all items subject to availability.



- Money order, certified check, cashier's check or bank wire deposit accepted.
- Include full telephone number on all mail orders.
- Include \$2.50 for postage and handling per software shipment (UPS).
- DC residents add 8% tax (if tax exempt, include number).

<b>HARDWARE</b>		
Enhancer II	149.00	<b>109.95</b>
Microtek 16K Ramcard	119.50	<b>89.95</b>
Softcard Premium System	775.00	<b>529.95</b>
System Saver	89.95	<b>69.95</b>
Videx Videoterm	345.00	<b>229.95</b>

<b>EDUCATION</b>		
English SAT #1	30.00	<b>21.95</b>
Master Type	39.95	<b>29.95</b>
Mathemagic	89.95	<b>69.95</b>
PSAT Word Attack Skills	49.00	<b>34.95</b>
SAT Word Attack	49.00	<b>34.95</b>

<b>UTILITIES</b>		
Artist*	99.95	<b>69.95</b>
Complete Graphics System	69.95	<b>52.95</b>
Graphics Magician	59.95	<b>44.95</b>
Merlin	64.95	<b>49.95</b>

<b>BUSINESS</b>		
Apple Speller	75.00	<b>54.95</b>
Data Factory 5.0	300.00	<b>229.95</b>
D.B. Master Utility Pack #2	99.00	<b>74.95</b>
Dictionary	99.95	<b>74.95</b>
E-Z Ledger	60.00	<b>44.95</b>
General Manager	149.95	<b>109.95</b>
Home Accountant	74.95	<b>54.95</b>
PFS: Graph*	125.00	<b>89.95</b>
Receivables (Broderbund)	495.00	<b>359.95</b>
ScreenWriter II	129.95	<b>94.95</b>
Word Star	375.00	<b>194.95</b>

<b>APPLE III</b>		
Data Manager III*	750.00	<b>579.95</b>
Desktop Plan III	300.00	<b>229.95</b>
PFS: Report	125.00	<b>89.95</b>
VisiSchedule III	300.00	<b>229.95</b>

\*PreRelease Special

\*PreRelease Special

# COLUMBIA COMPUTER SYSTEMS

Computers, Peripherals, & Software

**EXPERTISE, IN-STOCK MERCHANDISE, LOW PRICES**

Mail your orders to: P.O. BOX 40813, Washington, DC 20016

or call (202) 364-0273 any time, day or night

**We deliver to the Washington Apple PI meetings; call for details.**

# ELECTION REPORT

by Robert C. Platt

The annual Washington Apple Pi election mirrored our organization's recent growth. The election gives the new board not only a mandate, but also guidance through a referenda.

The following officers were elected to serve a one year term beginning July 1: David Morganstein, President; Dana Schwartz, Vice-President; Paula Benson, Secretary; and Edward J. Myerson, Treasurer. The six Directors-at-large are: Bernie Benson, Bruce Field, Nancy Philipps, Bernie Urban, Jess Wagstaff, and Richard S. Wasserstrom. The Librarian and Newsletter Editor also serve on the WAP Board.

The membership also had the opportunity to provide its views on the future course of the WAP. On the question of whether to incorporate WAP, 94% of those voting (596) favored incorporation, while 3% (19) did not. Eighty-eight per cent (563) would like to see cost estimates for office space included in the WAP budget, while 9% (55) would not. Fewer members favored a generally accessible office maintained by part-time paid staff (71%, 453); 21% (133) opposed this.

New WAP members are sent a package of materials about the club. On the question of whether to assess a new member fee, 38% (243) favored a fee which covers the cost of sending the package, 51% believed that the fee should provide some additional revenue beyond the cost of sending the materials, and 8% (49) opposed the new member registration fee.

The election went smoothly. A little under 40% of our membership cast valid ballots in the election. Given our ability to track through Apple manuals, it's not surprising that only two ballots were voided for not following directions. Also, twenty ballots received after the July 21 deadline were not counted.

Several members used their ballot envelopes to send address corrections or other messages to WAP. The election committee has forwarded these (including the generous contributions) to other officers for processing. Some of the ballots also included written comments. For example, one comment suggested that the new club office should be easily accessible to Virginia members. Several comments favored staffing the office with volunteers instead of paid staff. Other comments also stated that the new member fee should be kept low or that it be a suggested voluntary contribution.

I believe that referenda questions are a valuable part of the election and hope to see them continued in the future. Future elections could also be expedited by eliminating write-in votes and by adopting a form of machine readable ballot.

In conclusion, I take this opportunity to thank the volunteers who helped with the mailing and counting of the ballots. Thanks are also due to the members, whose continued participation and cooperation make WAP such a strong organization.

## HOTLINE VOLUNTEERS NEEDED

If you are interested in helping other WAP members with questions they have, read on. We are trying to expand our hot line service with new software and hardware coverage. If you feel competent to handle questions about any of the following items, please contact David Morganstein (301) 972-4263 with your phone number and any limitations on the hours you wish to be contacted.

Software.

-----

Data base packages: File Cabinet, Data Factory, VisiFile, DBASE II.

Graphics Packages: Super Hires Graphics, Sub-Logic A2-301, HiRes Text, HiRes Graphics, ZOOM grafix.

Communications Packages: VisiTerm, Z-term, ASCII Express.

Basic Compilers: TASC, Hayden, SDS.

Hardware.

-----

Super Serial Card, Versacard, CPS Multi-function card.

Printer interfaces: PKASO, Grappler.

Printers: NEC 8023A

If you need help in some other area, let us know and we'll try to connect you with help.

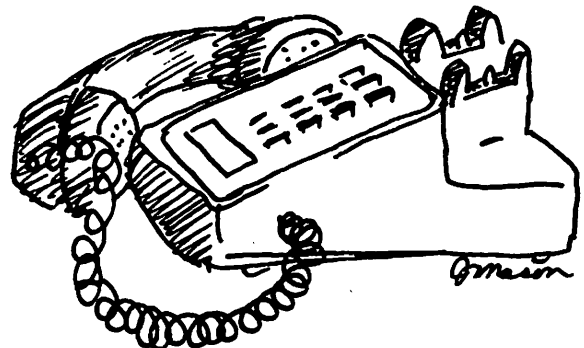

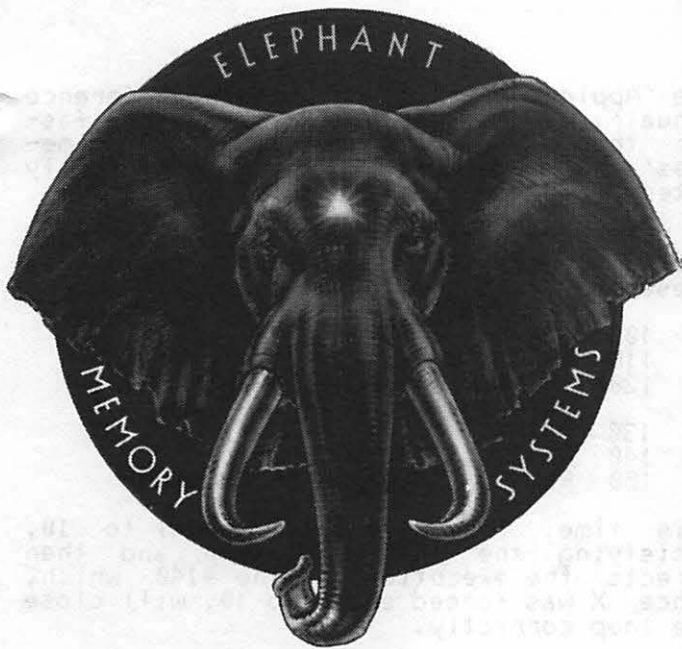

COME AND SEE THE  
NEWLY EXPANDED & RE-  
MODELED SHOWROOM  
AT THE COMM CENTER.  
WHILE YOU'RE THERE ..  
GET A FREE ELEPHANT  
MEMORY 5¼" DISKETTE  
CONTAINING PROGRAMS  
FOR YOUR APPLE!

— AND —

GET DETAILS ON  
COMM CENTER'S

## FREE DISKETTE-A-MONTH-CLUB!

### AUTHORIZED DEALER:

APPLE COMPUTER  
CORVUS SYSTEMS  
EPSON PRINTER  
SMITH-CORONA TP-1

### AUTHORIZED SERVICE:

APPLE COMPUTER  
EPSON PRINTER

### PHONE:

WASHINGTON & NORTHERN VA.  
BALTIMORE  
COMPUTER BULLETIN BOARD  
(WHEN STORE IS CLOSED)

953-9535  
792-0600  
953-1110



apple computer  
Authorized Dealer

# THE COMM CENTER



LAUREL PLAZA  
ROUTE 198, LAUREL, MARYLAND

OPEN: MONDAY thru FRIDAY  
10 AM to 8 PM  
SATURDAY-10 AM to 5 PM



apple® computer  
Sales and Service SINCE 1978

# JUMPING OUT OF A FOR NEXT LOOP

by James T. DeMay, Jr

Many times I find it necessary to jump out of a FOR-NEXT loop before the loop has been completed. This can be done with the IF statement. See the following example.

```
100 FOR X = 1 TO 10
110 INPUT A$(X)
120 IF A$(X) = 'DONE' THEN GOTO 150
130 NEXT X
140 PRINT
150 REM CONTINUATION OF PROGRAM
```

This method works, but beware! There is a gremlin hiding in there. Do you see it? The problem may never surface, especially if there are no more FOR-NEXT loops in the remainder of the program. A NEXT WITHOUT FOR error may be waiting to bomb your masterpiece. A FOR statement is continually in effect until the NEXT condition is satisfied. In our example, the FOR is in effect until X equals 10. If we jump out via line #120, X will not equal 10 and the loop will not be closed. Depending on the construction of the next FOR-NEXT loop, you may get a NEXT WITHOUT FOR error, or program execution could return to line #100, that is, if a 'nameless' NEXT was used. NEXT does not have to be used with a variable, as in NEXT X. In fact, according to

the 'Applesoft Basic Programming Reference Manual', a nameless NEXT will execute faster than a NEXT with a variable. A 'nameless' NEXT defaults to the most recently entered FOR loop that is still in effect.

A better way to exit this loop early, and still have the NEXT condition satisfied, is presented in the following example:

```
100 FOR X = 1 TO 10
110 INPUT A$(X)
120 IF A$(X) = 'DONE' THEN X = 10:
    GOTO 140
130 PRINT
140 NEXT
150 REM CONTINUATION OF PROGRAM
```

This time, line #120 sets X equal to 10, satisfying the NEXT condition and then directs the execution to line #140 which, since X was forced equal to 10, will close the loop correctly.

I have been using the technique in the first example for some time, and just recently became aware of the problem. I spent the best part of a day wrestling with a persistent NEXT WITHOUT FOR error, before I discovered where I had gone wrong. 

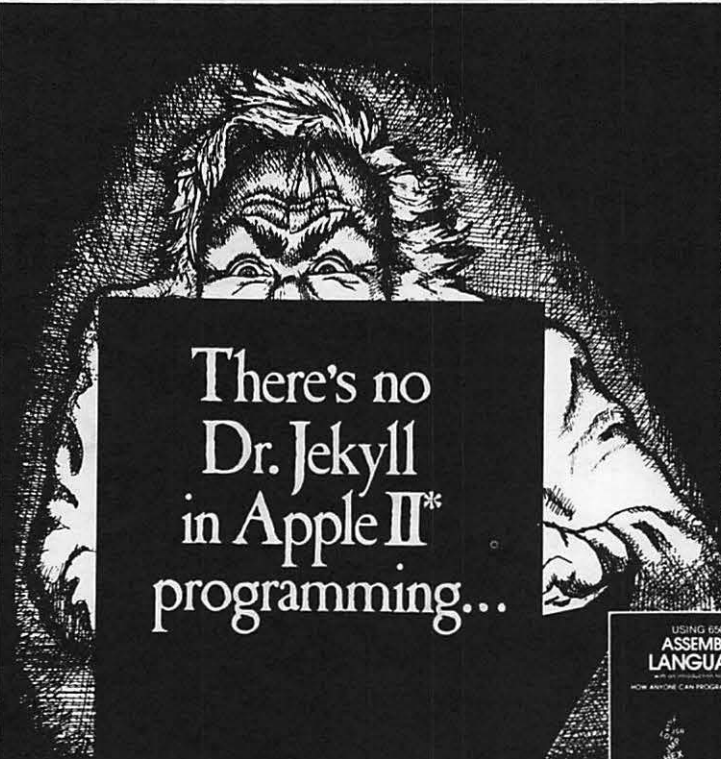

There's no  
Dr. Jekyll  
in Apple II\*  
programming...

Programming 6502 Assembly Language is no longer frightening or a monster problem. Because Randy Hyde has written *the* book that's easy to understand, easy to follow. It turns assembly language into the 'friendly language'. For anyone. For the average Apple II owner and the newest beginner.

Let Mr. Hyde get you started immediately, with string and math operations. See how to convert BASIC programs so they run up to 100 times faster! Discover Sweet-16, the 'hidden' 16-bit pseudo computer inside your Apple. Enjoy using your Apple to the maximum by following the step-by-step, practical examples... which turn you into a programmer in the blink of a chapter.

thanks to Mr. Hyde

\$19.95 per easy-reading copy at computer stores everywhere, or from:

**DATAMOST**  
19273 Kenya St.  
Northridge, CA 91326  
(213) 366-7160

VISA/MASTERCHARGE accepted.  
\$1.00 shipping/handling charge.  
(California residents add 6% tax)



\*Apple II is a trademark of Apple Computer, Inc.

# MORE TUTORIALS !

1. *An Introduction to the Apple: Microcomputer Fundamentals*  
July 31/Aug. 7 OR October 9/16  
Including: *Binary, Hex and ascii systems*  
*Bits, Bytes, nibbles, rams and roms*  
*The Memory Map and the Monitor*  
*Basic Programming*  
*The Disk Operating System - memory usage, the CATALOG,*  
*VTOC and DOS*

AND

2. *Applesoft Basic Programming - July 31/Aug. 7 OR October 9/16*  
Including: *The BASIC Language, variables and program control*  
*Input and Print*  
*Limitations and Restrictions*  
*Reading and Writing Files, EXEC'ing*  
*Graphics, Music and Miscellaneous*  
*Changing Program Control*

The tutorials will be held on two consecutive Saturdays, July 31 and August 7 OR October 9 and 16 at the Washingtonian Motel on Shady Grove Road in South Gaithersburg. There will be a limit of 24 participants at each tutorial. All tutorials will be taught by David Morganstein.

If you wish to attend one or both tutorials in a session, please fill out the form below. Enclose a check or money order made out to L. Morganstein Consultants for the appropriate fee. You will receive confirmation of registration and a list of suggested manuals and articles to read within two weeks. Mail form to:

L. MORGANSTEIN CONSULTANTS  
13329 Woodruff Court  
Germantown, Maryland 20874  
(301 972-4263)

\_\_\_\_\_  
NAME \_\_\_\_\_ HOME PHONE # \_\_\_\_\_  
ADDRESS \_\_\_\_\_ WORK PHONE # \_\_\_\_\_  
\_\_\_\_\_ WAP # (if applicable) \_\_\_\_\_

I will/will not bring and be responsible for an Apple, Disk Drive and Monitor.

(Pls. Ck.) \_\_\_\_\_ Intro to the Apple \_\_\_\_\_ Applesoft Basic

Each tutorial - with computer-WAP member \$45. Nonmember \$60.  
without computer " " \$60. " \$80.

# THE NEW ABBS, PART II

by Tom Warrick

This article is a continuation and update of an article, "The New ABBS," which appeared in the July issue of Washington Apple Pi. Several new features have been added to the ABBS since it was moved to 657-4507, and several features have been changed and improved. This article will not repeat material from last month's issue. (Back issues are available.)

## New Commands:

A - Amend a message in memory. After a message has been saved to disk, portions of it may still be changed using the "A" command. The "A" command gives access to the editing features of the "E" command. The "A" command, however, is for use only with messages already saved in memory. After you enter the message number, you will be given a chance to list the message prior to editing it.

? - "?" lists the letters of all available commands. Use it when you don't need to see the short description listed in response to the "H" command.

+ - "+" toggles an 80-column mode for users with 80-column boards or printers. If your system has 80-column capability, you can use this command to display text on one line that would normally take up two lines. Entry of material is not affected, and is always in 40-column mode. What the "+" command actually does is to change every other carriage return into a space.

In addition, these commands differ from their descriptions in the July issue:

E - "E" now has an edit capability. After you have entered a message, you will be given the option of saving your message as entered. If you select not to save the message immediately, you will be given the further choice of editing the message, re-entering the message from the beginning, or cancelling entry. If you select "E", you will be asked whether you wish to edit only the summary or a particular line number of the message. The line as it currently exists in memory will be displayed, and the cursor will return to the first character of the line. Use the right-arrow to copy those portions of the line that do not need to be changed. After editing a line, you will again be given the choice of saving the message to disk, or else editing a line, re-entering the entire message, or cancelling entry. Note that if you are using the "A" command, re-entering or cancelling the message both have the effect of deleting the message.

L and S - In response to the question asking how far back you wish to review messages, you may enter "ALL" or hit return rather than only a number. "ALL" will give you all messages on the system in chronological order. Hitting Return will give you only those messages entered today.

M - The Meetings file now also contains information on Tutorials sponsored by Washington Apple Pi.

S - When you review summaries of messages, you will first be given the option of "flagging" messages for later review in their entirety. If you select "Y" after a message's summary, you will see after the last summary line "HIT RETURN TO REVIEW FLAGGED MESSAGES". You should then turn on any memory program such as Data Capture, if you desire. You will then see a listing of messages exactly like that displayed by the "L" command, except that only flagged messages will be displayed. Note that ctrl-C or choosing to enter a message in the middle of a listing cancels the flagging routine. You would need to begin again with the "S" command.

X - As of the date this article went to press, the file upload routine was not entirely debugged. An appropriate announcement will be made on the ABBS when it is ready. You may, of course, still download files from the ABBS to your Apple.

A number of users have expressed difficulty using Data Capture 4.0 on the ABBS. Its principal problem appears to be that it is too slow. A program to remedy this, at least for D.C. Hayes Micromodem II owners, will be available soon through the ABBS and the Washington Apple Pi disk library.

## EDSIG by Nancy C. Strange

### EDSIG CALENDAR

Date: 10 August Tuesday, at 7:30 p.m.

Topic: Apple Pilot and Apple Pilot +

Peter Gruneau of the Institute of Applied Technology explains the advantages and disadvantages of Pilot and its latest implementation--Apple Pilot +.

Date: 14 September Tuesday at 7:30 p.m.

Topic: Computer Literacy

Diane Martin, a computer literacy consultant, who made a brief introduction to computer literacy at the July EDSIG Meeting, will be back to give us a more in-depth presentation. All teachers and parents who realize the importance of this topic are invited to join us.

July 13th EDSIG Meeting Report

The Language Arts presentation scheduled for the July meeting was postponed, but two last minute substitutes provided excellent presentations.



## WP in Elementary Schools

The first was on the use of word processors in the elementary schools by Virginia Bradley, who is working on her PhD in Reading Education. She used subsets of three Apple Word Processors (Easywriter, Apple Writer and SuperText) in conducting two studies in an Anne Arundel County elementary school this spring. She researched how well first graders were able to have a language experience of creating a story (with the teacher typing in the contributions into the computer) rather than with a wall chart. The results were that each child was more eager to contribute. There were spontaneous corrections and the stories that were created were longer and **contained more details. Obviously the ability to store and manipulate words with a word processor, removed some of the barriers to creative writing: The child did not get tired of the physical writing and start to generalize or end the story abruptly; it made making modifications easier and less threatening. In addition, the printer adds the enhancement of providing each child with a copy of their creation.**

Virginia also shared how she used the three word processors with sixth graders in doing sentence combining tasks. Each child had an Apple with a word processor and was given varied sentence combining exercises to do. It was found that of the three processors, the subsets of Apple Writer and Easyprinter with commands that had associations were easier to use. The Apple Writer version used, had the problem of splitting words between lines and therefore Easyprinter was selected to be best of these versions.

Ms Bradley suggests the following requirements for an elementary school word processor system. It should have:

- 1) Screen Editor
- 2) Monitor
- 3) Upper and lower case display
- 4) Double spacing display
- 5) Optional typefaces:
  - A) large Primary-type for younger kids
  - B) 80 columns for older kids
- 6) Left arrow deletion
- 7) Mnemonic commands (easily associable)
- 8) Printer (that is quiet)
- 9) Built-in dictionary

### Computer Literacy Intro

A brief introduction of computer literacy was made by Diane Martin, a computer literacy consultant. She defined computer literacy as having two levels: that of Awareness of Computer Impact and that of Functional Knowledge. There is some debate as to what level of understanding is necessary for someone to be computer literate. Here is the breakdown as to what both of the levels involve:

- Lev 1: Awareness of Computer Impact
- A. History of computers and numbers
  - B. How computers work
  - C. Algorithms and problem solving

- D. Applications of computers
- E. Social implications
- F. Attitudes about computers

### Lev 2: Functional Knowledge

- G. Computer use:
- Programming
  - Information retrieval system
  - Word processing

The first level could be explained without ever having a computer, but the second requires it.

Diane Martin has just co-authored with Rochelle S. Heller "Bits n' Bytes About Computing -- A Computer Literacy Primer." It is a book geared to teachers with no computer science background and contains numerous activities for the student. Ms Martin will be making a more in-depth presentation of the topic at the September 14th EDSIG meeting.

### TURTLE TRACKS

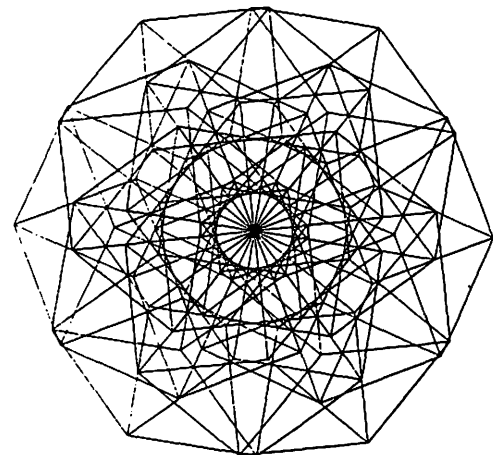

### LOGO IS HERE!

There will be a general meeting for all people interested in LOGO on 24 July after the WAP meeting in Bldg A, Lecture Room A. The purpose of the meeting will be to gather and discuss how we can work together to help LOGO's implementation in the Washington, DC area. Please come with ideas and suggestions on how we can organize, what we can do, and especially what part YOU would like to have in a LOGO group.

LOGO is still available for a group purchase. Anyone interested should contact Nancy Strange, 691-1619.

Special note should also be taken that the Byte language issue, August, will be on LOGO this year.

# LETTER TO THE EDITOR

6327 Western Ave., N.W.  
Washington, D.C. 20015  
10 July 1982

Attention: Editor  
Washington Apple Pi, Ltd.  
P.O. Box 34511  
Bethesda, MD 20817

Dear Sir:

My article, "Your Diskettes Cost Too Much" in your June issue, seems to have generated both strongly favorable and strongly critical comment. In your July issue you published a critical letter by Val Golding, whose name is certainly familiar to all but the newest of Apple owners. I myself have benefited from Val's extensive knowledge about the Apple. It is therefore with some surprise that I read his criticisms, especially about the safety of using diskettes two-sided.

As a specialist in diskette usage (with VF Associates), I am familiar with both the manufacturing process and the American National Standards Institute specifications for floppy diskettes. A single-sided diskette bears a manufacturer's label on one side. Many non-Apple micro-computer drives write their magnetic data on this label side when the diskette is inserted as usual. No manufacturer knows at the time of certification which side, label or non-label, will be the primary side in use, if the diskette is sold for all micro-computers. Hence the idea that one side receives a better certification than the other is legitimately classified as a "myth", as I called it in my original article. Any difference in failure rate between the two sides of a diskette must have some local explanation (e.g. a dirt-encrusted pressure pad), and cannot be related to the quality of magnetic coating on the respective sides.

Val's letter concludes with a very good idea -- find out what the in-house policy of the larger software houses is. I would like to report here the results of such a survey:

**ON-LINE SYSTEMS.** Use most in-house diskettes two-sided. Buy single-sided, and notch the other side themselves. No problems with general use. Market hires adventures on two-sided diskettes.

**BRODERBOND.** Some two-sided use in-house. Typically will keep working copies on the backs of master diskettes. Cautions that if consumers use backs of Broderbond diskettes, warranty may be voided.

**SIRIUS.** Ordinarily use backsides for backups.

**OMEGA.** Use second sides for backups, including marketed software.

**CONTINENTAL.** No in-house policy. Each author does as he chooses.

**QUALITY SOFTWARE.** Use one side only because "too much trouble to punch holes". Nevertheless, describe practice of double-sided diskettes as "very practical".

These are all of the companies I contacted, and assume they are a representative sample. Most were unwilling to be quoted about their preferred brands, and in any case there was certainly no consensus about which were best, with economic considerations very much in evidence.

While talking with Quality Software, I learned that "Beneath Apple DOS" authors Don Worth and Pieter Lechner have both used diskettes routinely on both sides.

I have spoken with Mr. Golding since his letter was published, and he expressed interest in the survey's results, and a shared interest in getting the truth to the consumers. We discussed some additional work which could lead to publication of a more extensive version of my article in "Call A.P.P.L.E.". Although only about one-tenth as many individuals have reported bad experiences with two-sided use as have been pleased with it, the one common attribute that Val and the few others share is having had their Apples over three years, with relatively little recent experience on the subject. This suggests the theory that there has been a real change in the situation recently. For example, it is now rare to hear of the kind of problems that Verbatim (among others) experienced with quality control in their earlier efforts.

In summary, while some caution is always in order, most micro-computer owners would surely find themselves economically way ahead to follow the lead of the major diskette users and press those certified but idle second surfaces into regular service.

Sincerely yours,  
Tom Van Flandern, Ph.D.

## CONSUMER'S UNION

Consumers Union is preparing to evaluate personal computers. They are interested in your experiences in buying, learning to operate, and running them.

If you are interested in participating in C. U.'s survey and filling out its questionnaire send in your name and address, along with the brand and model of your computer to:

Consumer Reports  
P. O. Box RME  
256 Washington Street  
Mount Vernon, N. Y. 10550

# Step Into the Future!

## SYSTEM PACKAGE APPLE II PLUS



Includes:	List
Apple II Plus, 48K RAM	\$1,530.00
Disk II with Controller, DOS 3.3	645.00
Apple /// Monitor	249.00
Monitor Stand	29.95
Apple Writer II Word Processor	150.00
<b>TOTAL</b>	<b>\$2,603.95</b>

\* Price guaranteed to be lowest in Washington area.

VISA, MasterCard accepted.  
Items subject to availability and price change.

COMING SOON! - Washington's largest personal computer center will include retail store, business store, learning center, computer lab, video classroom & service center. Watch the Post Monday business section for Grand Opening specials.

# Clinton Computer

## \$ 4 7 9.<sup>00</sup>

# NEC 8 0 2 3



**Helps you do better  
what you do best.**

**\*\*TECH TIP\*\*** \*TECH TIP\*\*



Intermittent failures may be caused by loose chips on the motherboard. Turn off power and gently push down each chip into its socket. If problem persists, call our service center.

PI Members Only - Special

Elephant Memory Diskettes  
\$22.95  
(5¼" Single Density)



===== COUPON GOOD FOR =====  
APPLE ][ EXTENDED WARRANTY

\$ 1 7 9 . 9 5 \* (Reg. \$225.00)

NO COST FOR INSPECTION

\* Add \$20.00 if not a Washington Apple Pi member  
Expires July 30, 1982

===== CLINTON COMPUTER =====

*Chris Muhl*

*John Schubert*

9020-C Woodyard Road Clinton, Md.  
Route 5 South from Beltway  
Right on Woodyard Road (Route 223)

**868-0002**

 **apple computer**

**Authorized Dealer & Service Center**

# SWITCH SELECTED ENABLE/DISABLE FOR SLOT ZERO

by Dave Weikert

NOTE: Unauthorized modifications to your Apple II/III+ computer will void your warranty. This modification is designed so that it may be installed and later removed should any service be required. The author has built and satisfactorily tested this device but neither the author nor Washington Apple Pi will be responsible for any damages resulting from its construction or use.

## INTRODUCTION:

The hardware device described in this article allows the user to disable the RAM card located in slot zero by a switch action. The device was fabricated from parts easily obtainable through local sources (Radio Shack Arlington Electronic Wholesalers, etc.) at a cost of less than \$6.00. It can be assembled and tested in less than one hour by anyone with a little experience in soldering and kit assembly.

Why would anybody want to disable the RAM card in slot zero? Well, there a number of reasons that I can think of and probably many more that I can't. Many programs will determine if a RAM card is present in slot zero and if it is, will use it. Some greetings programs (such as the one on the Apple System Master) will load the alternate language into the RAM card. The club library has a program on Volume 101, Utilities B, that relocates DOS to the RAM card. VISICALC uses the installed RAM card to ex-pand the memory available for row-column operations. You may want to run a program without losing what was previously loaded into the RAM card; the modification described in this article allows this. For example, you may want to retain the alternate language in the RAM card so it is not necessary to keep rebooting the disk with the greetings program that loads it. To do this, disable the RAM card with the switch during the time that you are loading and running any program that would write over the alternate language loaded in the RAM card. When you are done with the other program, boot the next program and enable the RAM card to continue with the alternate language intact.

## DESCRIPTION OF THE DEVICE

The device replaces the 74LS138 integrated circuit located in the H2 socket on the Apple II/III+ mother board. The device consists of the same type integrated circuit (74LS138) which is mounted on a 16 pin header in such a way as to allow rerouting the output of pin 15 through a switch. The switch selects either the output of pin 15 of the 74LS138 (the device 0 select or not

select signal) or of pin 16 (a voltage level always equivalent to device 0 not select) and routes it to pin 15 of the 16 pin header which is plugged into the H2 socket. Figures 1 depicts the completed unit.

The device design may be modified to disable any other slot by selecting the appropriate pin on both the 74LS138 and the DIP header instead of pin 15 and routing them through the SPDT switch. The pins for the other slots are:

Slot 1 - Pin 14	Slot 5 - Pin 12
Slot 2 - Pin 13	Slot 6 - Pin 9
Slot 3 - Pin 12	Slot 7 - Pin 7
Slot 4 - Pin 11	

Additional switches may be installed if multiple slots are to be disabled thus allowing for more than one slot at a time to be disabled.

## PARTS REQUIRED:

- 74LS138 Integrated circuit.
- Single Pole Double Throw (SPDT) switch, 16 pin Dual In-Line package (DIP) header.
- 16 pin DIP socket.
- 12 inch length of 3 conductor ribbon cable.
- 3 inch length of 3/8 inch shrink tubing.

## ASSEMBLY INSTRUCTION (See Figure 1):

- Insert the 16 pin DIP header (Item c) into the 16 pin DIP socket (ITEM D). (The socket is used as a jig during construction to prevent the displacement of the pins in the header during soldering.)
- Separate the three conductors of the ribbon cable (Item e) for approximately 2 inches from each end by cutting parallel to the conductors with a sharp knife or razor blade. Strip both ends of each conductor approximately 1/8 inch and tin.
- Lay one end of the ribbon cable across the top of the DIP header. Insert the tinned end of one wire in the slot in pin 15 and solder. Repeat for pin 16 and cut off any excess (protruding) wire at each pin.

CAUTION: Attach a heat sink to the integrated circuit (Item a) pins prior to each soldering operation described in steps 4 and 5. Use a low wattage, pencil type soldering gun.

- Bend pin 15 of the integrated circuit to the inside until it is nearly flat against the bottom. Insert the remaining wire from the same end of the ribbon cable under pin 15 of the integrated circuit and solder. Cut off any excess wire.

5. Place the integrated circuit on top of the DIP header so that the integrated circuit pins overlap the header pins. Solder each integrated circuit pin to the corresponding DIP header pin (except for pin 15). Pin 15 of the integrated circuit should not be contacting pin 15 of the header.

6. Insert the other end of the ribbon cable through the shrink tube (item f.).

7. Connect the opposite end of the conductor soldered to pin 15 of the header to the center pin of the SPDT switch (Item b) and solder.

8. Connect each of the remaining two wires to each of the two pins on the SPDT switch and solder.

9. Cut off any excess wire, slide the shrink tube over the contacts of the switch and apply heat to the shrink tube to shrink it.

10. Remove the completed DIP header from the socket and discard the socket.

11. Remove the 74LS138 integrated circuit from location H2 of your Apple II mother board using an integrated circuit extractor. (The H2 location is just in front of slot 0.)

12. Insert the completed DIP header in location H2 and run the cable and switch out the back of the computer. The U-shaped locator depression in the integrated circuit should face towards the keyboard.

## TESTING AND USE:

Test the device by booting the Apple System master disk. Find the switch position that allows the alternate language to load at boot and label this position "SLOT 0 ENABLE". Label the other position "SLOT 0 DISABLE". Ensure that the alternate language does not load when you power off and then on again with the switch in the "SLOT 0 DISABLE" position.

If the alternate language does not boot with the switch in either position, look for a short circuit between the pin 15 header and pin 16 or a short circuit between pin 15 on the integrated circuit and pin 16 or a short circuit at the switch. If the alternate language always loads no matter what the position the switch is in, look for an open between pin 16 and pin 15 through the switch.

In the "SLOT 0 DISABLE" position the SPDT switch will disable any RAM card located in slot zero. In the "SLOT 0 ENABLE" position your Apple II will operate just as it always has.

6

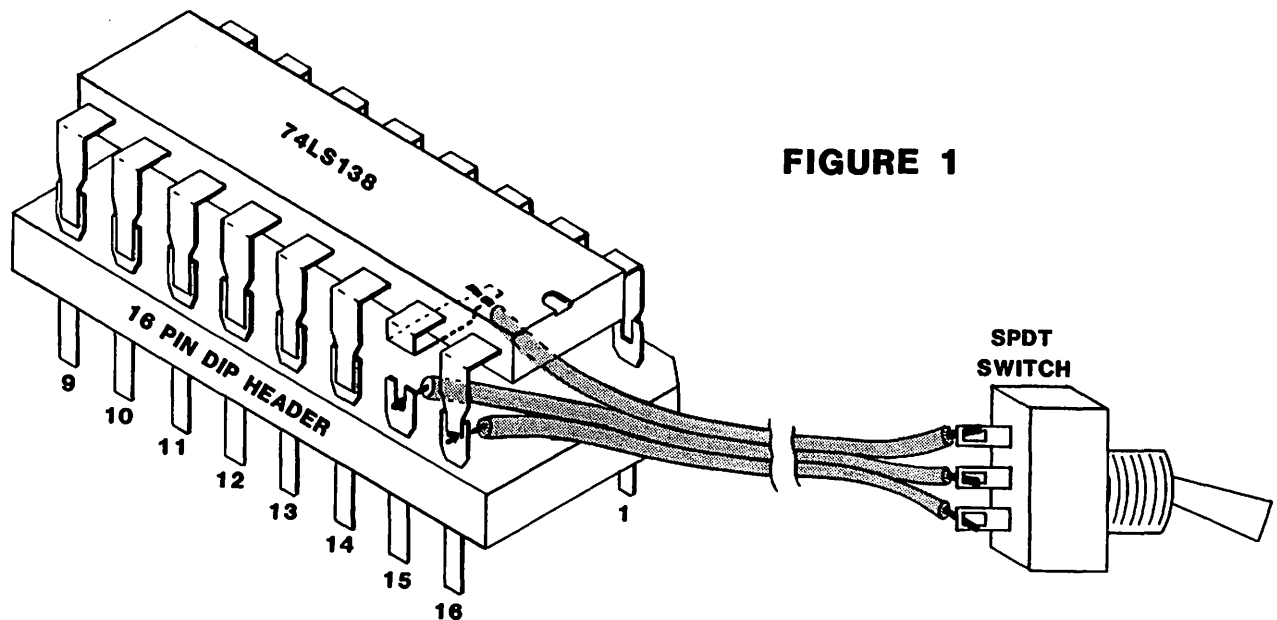

FIGURE 1

- Two DB-25 connectors for system I/O
- Three blank Spaces for DB-25's
- The Composite Video Connectors
- A DB-9 Connector for RGB Video Out
- A DIN Connector for Cassette In/Out
- A Ribbon Cable Entry Slot

# BASIS

## 108



- Characters
- 80 Horiz. X 40 Vert., plus 4 Lines of Text, 80 Characters
- 280 Horiz. X 160 Vert., plus 4 Lines of Text, 80 Characters
- 280 Horiz. X 160 Vert., plus 4 Lines of Text, 80 Characters

### KEYBOARD

The keyboard for the BASIS 108 features an exceptionally low profile design that is both attractive and functional. It is just over one inch in height and weighs about five pounds. The keyboard is connected to the CPU with a coiled cable approximately five feet in length, allowing maximum operator freedom and convenience. The keyboard consists of 100 keys that are separated according to function into 4 groups:

- Standard ANSI Typewriter Keyboard
- Numeric Keypad
- Cursor Control Block
- Programmable Function Keys

The keyboard output is sent to the motherboard where it is decoded by a ROM programmed with mapping and character set information. This arrangement permits tremendous keyboard flexibility. By simply exchanging the standard ROM for one with different programming, you may have any keyboard configuration or set of characters (language) desired. When more sophistication in keyboard handling is desirable, it is possible to select a keyboard interrupt mode of operation.

System packaging for the BASIS 108 is attractive, practical, and complete with built-in capability for system expansion. As your system grows, it will remain a compact, self-contained package instead of the awkward proliferation of boxes, cables, and adaptors that are characteristic of most microcomputer systems.

### VIDEO

The BASIS 108 offers a wide range of video display capabilities. The system provides Normal, Inverse, and Blinking displays, two Text modes, and three Color Graphic display modes.

#### TEXT DISPLAY

- 40 Columns X 24 Lines
- 80 Columns X 24 Lines

#### GRAPHICS DISPLAY

- 40 Horiz. X 48 Vert.; 15 Colors
- 80 Horiz. X 48 Vert.; 15 Colors
- 280 Horiz. X 192 Vert.; 6 Colors

The BASIS 108 has three separate video outputs to accommodate any display mode. These outputs are:

- Composite Black and White Video
- Composite Color Video
- RGB Video Output

The system also allows soft-switch selection of four character sets, permitting tremendous display flexibility.

The BASIS 108 offers compatibility, and more . . . a lot more. More computing power. More memory. More utility. More of everything you want in a microcomputer system . . . for a lot less.

### STANDARD FEATURES

- 6502 and Z80 microprocessors
- 64K RAM Expandable to 128K
- 2K System ROM, plus sockets for 10K additional user ROM
- RGB and Composite (NTSC) Video
- Selectable 80 or 40 Column Text display
- High Resolution Graphics: Six Colors, 280X192 or 280X160 with four lines of text
- Color Graphic Mode: 15 Colors 40X48 or 80X48; 40X40 or 80X40 with four lines of text
- 8 bit parallel output
- RS-232c Serial I/O
- Detached Keyboard: All standard keyboard functions, Upper/Lower case characters, Numeric Keypad, Cursor Control Block, and 15 programmable function keys.
- Built-in mounting for two 5¼ inch floppy disk drives
- Six Apple II compatible slots for plug-in peripherals
- Game paddle I/O
- Built-in loudspeaker
- Two accessory power outlets
- Mounting slots for up to six DB-25 I/O plugs

Hardware and Software compatible with Apple II™

## FUTURE TECHNOLOGY CORPORATION

1735 TWENTIETH STREET, N.W.  
WASHINGTON, D.C. 20009 U.S.A.

(202) 785-1599

<sup>1</sup>APPLE and APPLE II are trademarks of Apple Computer, Inc.

<sup>2</sup>CP/M is a trademark of Digital Research.

© 1982 BASIS, INC.

*Call now to schedule your demonstration!*

# BASIS 108



## THE ALTERNATIVE

**Hardware and Software  
compatible with Apple II'**



### COMPATIBILITY

The BASIS 108 dual processor microcomputer system has features and capabilities not found in systems many times more costly. But more importantly, the system is compatible with the largest library of microcomputer software and plug-in peripherals available today. Its design and organization permit the BASIS 108 to be compatible with most programs and peripherals originally developed for use with the Apple II™ microcomputer, including CP/M™ based applications software packages.

THE KEY ..... COMPATIBILITY  
THE ALTERNATIVE ..... BASIS 108.

### DUAL PROCESSORS

The BASIS 108 is equipped with both 6502 and Z80 microprocessors, and up to 128K of RAM. As the 6502 and Z80 can only address a 64K memory area, the RAM is split into two banks, and bankswitched as required during processing. With dual processors and bankswitched RAM capability, the system offers tremendous utility for computing tasks at all levels. The BASIS 108 will fit your needs; for personal use, professional use, or complex business applications that require more computing power.

### MEMORY

Memory capacity should never be a problem with the BASIS 108, with more built-in RAM than any comparable microcomputer system (64K to 128K). The system has a

2K monitor ROM, plus five sockets for additional ROM's or EPROM's of 2K each, for a total of 10K of user ROM space. The central processing unit (CPU) allows internal mounting of two 5¼ inch floppy disk drives for a total storage capacity of more than one-half megabyte.

### SYSTEM PACKAGING

The BASIS 108 is a single-board microcomputer system, configured with a detached keyboard and separate CPU. This arrangement makes it easy to configure various work station set-ups.

### CPU

The cast-aluminum CPU housing is designed for use in any environment. Its design provides excellent shielding characteristics, eliminating all concerns about radiated interference (RFI, EMI, etc.).

Within this housing are the single-board CPU, six APPLE compatible peripheral slots (2-7), power supply, and space for mounting two floppy disk drives. All system inputs and outputs are located on the unit's rear panel. Included are:

- Power Input
- Two Utility Power Outlets
- A DB-25 Connector for Keyboard I/O

# IAC CORNER

by Bernie Urban

Some good news. Soon to be available at your favorite Apple Dealer are the Apple Tech Notes compiled from responses to thousands of letters and telephone calls to Apple Computer, Inc. and the International Apple Core. IAC will be sending one copy of this 450 page reference book to each of its member clubs, together with coupons for their members which are good for a \$7.50 discount off the retail price of \$64.95 at the dealer. The Apple Tech Notes are being published in notebook form and quarterly updates will be available to individual purchasers by subscription. The material is organized by subject, using tabs and indexes. So far there are about 50 categories covering computer internals, peripheral hookups and operation, languages, etc. I suggest that you schedule a personal viewing through your club officers.

At the July 8th meeting at the IAC office in Santa Clara, work on the business plan proceeded well, and it will be sent to the Directors for their review and approval within the next few weeks. A few hints as to possible services and goodies for the member clubs ... hardware insurance, special publications from the SIG's and elsewhere, a "People's Message System", a feedback mechanism for sponsoring members, course materials, newsletter abstracts, and more.

In the meantime, if anyone is interested in volunteering to chair a SIG of international scope, contact Lou Milrad (IAC's V.P. in charge of SIGs) at (416) 222-8447. Be sure first that you are ready to commit to much time and effort for this. @

## TUNING OUT THE AUDIO by Jane Mason

My husband, who hates computers, went to bed early, exhausted. Deciding to take another stab at debugging a troublesome program, I went to my "computer room" and closed the door so my printer, which sounds like a sledge hammer, would not wake him. I worked and worked and finally, about midnight the program worked! Elated, I went in to start my bath water, returning to the computer room to shut off the machines. But--there was a way to quickly improve the program.

About an hour later, as I was almost finished with my quick improvement, I heard a rustling noise. Thinking the cat wanted to join me, I opened the door--and the water poured in.

I shrieked. My husband sleepily lumbered up, threatening as a bear. We each had a floor of our own to mop, so I never heard what he had to say. @

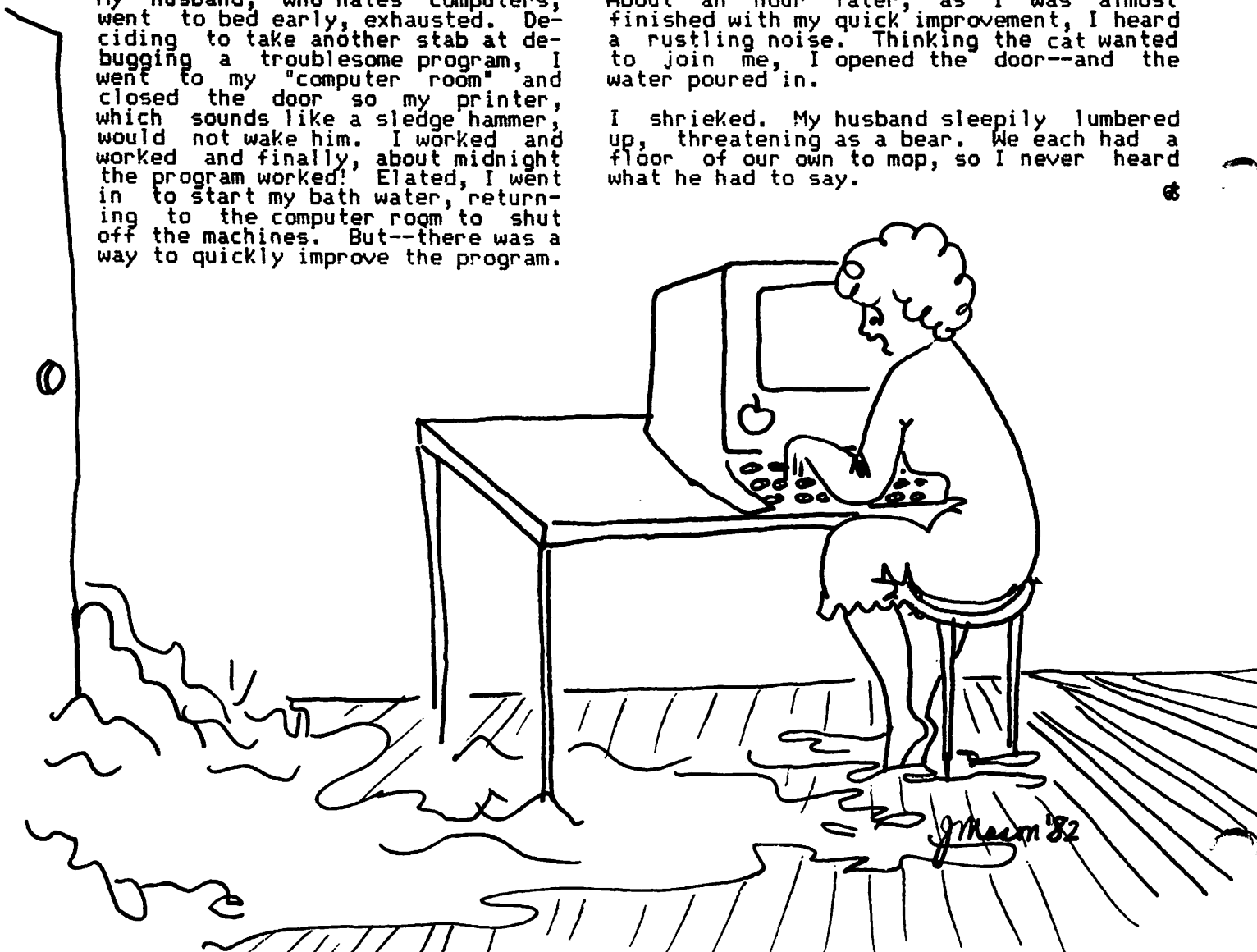



-----  
**WASHINGTON APPLE PI**  
**MAIL ORDER FORM**  
 -----

Washington Apple Pi has a program library, and disks are available for purchase. You may pick them up at the monthly meeting or have them mailed for \$2.00 per disk additional. (If you order five or more the additional charge will be \$10.00 total.) If you plan to pick them at the meeting, the order must be received by the 1st of the month, and must be paid in advance.

**PROGRAM DISKETTES**

Members: \$5.00 picked up at meeting  
 \$7.00 mailed to you (for the first five, remainder at \$5.00)

Non-members: \$8.00 per disk picked up at meeting  
 \$10.00 mailed to you (for the first five, remainder at \$8.00)

DOS 3.2		DOS 3.3	Volume 180	Dungeon Designer	( )
Volume 1	Utilities I	( )	Volume 181	Beginners Cave	( )
Volume 2	Utilities II	( )	*Volume 182	Lair of Minotaur	( )
Volume 3	Games I	( )	*Volume 183	Cave of the Mind	( )
Volume 4	Games II	( )	*Volume 184	Zyphur Riverventure	( )
Volume 5	Games III	( )	*Volume 185	Castle of Doom	( )
Volume 6	Games IV	( )	*Volume 186	Death Star	( )
Volume 7	Games V	( )	*Volume 187	Devil's Tomb	( )
Volume 8	Utilities III	( )	*Volume 188	Caves of Treas. Island	( )
Volume 9	Educational I	( )	*Volume 189	Furioso	( )
Volume 10	Math/Science	( )	*Volume 190	The Magic Kingdom	( )
Volume 11	Graphics I	( )	*Volume 191	The Tomb of Molinar	( )
Volume 12	Games VI	( )	*Volume 192	Lost Island of Apple	( )
Volume 13	Games	( )	*Volume 181	required with these disks.	( )
Volume 14	IAC Utilities IV	( )	DOS 3.3		
Volume 15	Games VII	( )	Volume 100	Utilities A	( )
Volume 16	Utilities V	( )	Volume 101	Utilities B	( )
Volume 17	Graphics II	( )	Volume 102	Games A	( )
Volume 18	Educational II	( )	Volume 103	Merry Christmas	( )
Volume 19	Communications	( )	Volume 104	Business A	( )
Volume 20	Music	( )	Volume 105	FIG-FORTH/Utilities	( )
Volume 21	Apple Orchard	( )	Volume 106	Science/Engineering	( )
Volume 22	Utilities VI	( )	Volume 107	Games B	( )
Volume 23	Games VIII	( )	Volume 108	IAC 10 (Graphics)	( )
Volume 24	Games IX	( )	Volume 109	IAC 11 (Applesoft Tut.)	( )
Volume 25	Utilities VII	( )	Volume 110	Personal/Education	( )
Volume 26	Stocks/Investments	( )	Volume 111	Games C	( )
Volume 27	Math	( )	Volume 112	Utilities C	( )
Volume 28	Planetfinder	( )	Volume 113	Business B	( )
Volume 29	Utilities VIII	( )	Volume 114A	Adventure - INIT	( )
Volume 30	Games X	( )	Volume 114B	Adventure	( )
Volume 31	Plot Utilities	( )	Volume 115	IAC 12/13 Miscellaneous	( )
Volume 32	Games XI	( )	Volume 116	IAC 14 Micromodem II	( )
Volume 33	Accounting	( )	Volume 117	Picture Packer	( )
Volume 34	Solar Tutor	( )	Volume 301	PIG1: (Pascal)	( )
Volume 35	Garden Management	( )	Volume 302	PIG2:	( )
Volume 36	Games XII	( )	Volume 303	PIG3:	( )
Volume 37	Utilities IX	( )	Volume 304	PIG4:	( )
Volume 38	Games XIII	( )	Volume 305	PIG5:	( )
Volume 39	IAC VII	( )	Volume 306	PIG6:	( )
Volume 40	IAC VIII	( )	Volume 307	PIG7:	( )
*Volume 193	The Abductor's Qtrs.	( )	Volume 118	Dos 3.3 Utilities D	( )
*Volume 194	The Quest for Trezore	( )	Volume 119	IAC 15, Misc.(3.3)	( )
*Volume 195	The Underground City	( )			

TOTAL ORDER = \$ \_\_\_\_\_

Check here if you want these shipped \_\_\_\_\_ (NOTE: ALLOW 6 to 8 WEEKS FOR MAILING.)

ALSO, Look at new disks mentioned in "A Page From The Stack"

NAME \_\_\_\_\_

ADDRESS \_\_\_\_\_

CITY, STATE, ZIP \_\_\_\_\_

TELEPHONE \_\_\_\_\_ WAP MEMBERSHIP NO. \_\_\_\_\_

Make checks payable to "Washington Apple Pi"  
 Send order to: Washington Apple Pi- ATTN: Librarian  
 PO Box 34511  
 Bethesda, MD 20817

WAP TUTORIAL REGISTRATION

A WAP tutorial on Personal Finance Programs will be taught by Ms Robin O. Oegerle. She is President of Financial Strategies Incorporated.. It will be held on Saturday, September 11, 1982, 9:00 A.M. to 12:30 PM, in room 2017A at USUHS on Jones Bridge Road (on the campus of the Bethesda Naval Medical Center) in Bethesda, MD. Check the club phone and ABBS for any change in details.

The fee is \$15 if you bring your APPLE; \$30 if you do not.

Please add \$5 to the fee if you are not a WAP member.

Name \_\_\_\_\_

Daytime Phone \_\_\_\_\_ Evening Phone \_\_\_\_\_

Check One;

I will bring an Apple, etc. (fee \$15, WAP Membership Number \_\_\_\_\_) Non-member + \$5. \_\_\_\_\_

I will not bring an Apple (fee \$30, WAP Membership Number \_\_\_\_\_) Non-member + \$5. \_\_\_\_\_

Please return application and check made out to "Washington Apple Pi" to:

Joe Silverman  
14405 Tarbon Terrace  
Silver Spring, MD 20904

A WAP tutorial on Assembly Language will be taught by Tom Warrick, who is our ABBS. It will be held on Saturday, October 16, 1982, 9:00 AM to 12:30 PM, in room 2017A at USUHS on Jones Bridge Road (on the campus of the Bethesda Naval Medical Center) in Bethesda, MD. Check the club phone and ABBS for any change in details.

The fee is \$15 if you bring your APPLE; \$30 if you do not.

Please add \$5 to the fee if you are not a WAP member.

Name \_\_\_\_\_

Daytime Phone \_\_\_\_\_ Evening Phone \_\_\_\_\_

Check one;

I will bring an Apple, etc. (fee \$15, WAP Membership Number \_\_\_\_\_) Non-member + \$5. \_\_\_\_\_

I will not bring an Apple (fee \$30, WAP Membership Number \_\_\_\_\_) Non-member + \$5. \_\_\_\_\_

Please return application and check made out to "Washington Apple Pi" to:

Steve Stern  
6921 Old Stage Road  
Rockville, MD 20852

Tom Woteki has agreed to teach a four-session tutorial in November. We are interested in whether members want a basic level tutorial or an advanced level which would be a follow-on to his tutorial on Pascal last Spring. Please call Dr. Woteki at 547-0984.

Eve  
introduced  
the apple to  
Adam



Now  
we've brought it  
to Bethesda

Can we tempt you?

As your authorized Apple dealer, Bethesda Computers specializes in the sale of micro-computers, software, peripheral equipment & accessories. Drop by for a "hands-on" demonstration and professional analysis of your computer needs.



Bethesda Computers  
8020 Norfolk Avenue  
Bethesda, Maryland 20014  
(301) 657-1992

Washington Apple Pi  
P.O. Box 34511  
Bethesda, MD 20817

BULK RATE  
U. S. POSTAGE  
**PAID**  
PERMIT #101  
Glen Echo, MD  
20812

ADDRESS CORRECTION REQUESTED

---

---

A REFURBISHED DAISY WHEEL TERMINAL  
FOR PERSONAL COMPUTER USERS AND SMALL BUSINESSES.

## Now you can have letter-quality printing and professional features for just ~~\$1,495\*~~

NOW REDUCED TO \$650.

AJ daisy wheel printer terminals are renowned for exceptional performance, high reliability, and applications versatility. Now you can have all this for only \$1,495\* in our special limited offer.

- 30 cps *letter-quality* printing
- Changeable type faces
- Full ASCII keyboard with numeric pad
- High resolution X-Y plotting
- Complete electronic forms control
- 128-character buffer
- Asynchronous RS-232 interface
- Printwheel, ribbon cartridge, and cable included
- 30-day parts/labor warranty

And you can choose from a list of options including forms tractor, pin-feed platen, paper trays, side shelves, extra printwheels, APL keyboard and 2K buffer.

Call your nearest AJ regional office for details: San Jose, CA (408) 946-2900; Rosemont, IL (312) 671-7155; Hackensack, NJ (201) 488-2525. Or check the phone book for the number of your local AJ sales/service office.

\*Price excludes options and is subject to change without notice. Model shown includes certain options. Offer available only in the contiguous U.S.



**ANDERSON  
JACOBSON**

---

IF INTERESTED IN A PURCHASE OR A PERSONAL DEMONSTRATION  
PLEASE CALL (301) 840-5700.

IN MARYLAND - SEAN BELANGER  
IN VIRGINIA - JIM BURRELL  
IN WASHINGTON - JOHN NOBLE